

COMPUTERFACTS™

Technical Service Data

APPLE®
APPLE II, II PLUS
COMPUTER



FEATURES COMPLETE SCHEMATICS • PRELIMINARY SERVICE CHECKS • TROUBLESHOOTING TIPS •
EASY-READ WAVEFORMS • REPLACEMENT PARTS LISTS • SEMICONDUCTOR CROSS-REFERENCE

HOWARD W. SAMS & COMPANY

Remove staples and use cover for file folder.

COMPUTERFACTS™ put easy to use, informative technical data right at your fingertips. Each edition includes specific service information on the individual component, along with some overall troubleshooting hints.

The following information is just a sample of the many valuable time saving features contained in this exclusive Sams COMPUTERFACTS publication:

- Preliminary Service Checks section is an easy to use, step by step guide for the experienced technician or hobbyist, and even beginners.
- SAMS famous industry accepted standardized notation schematics containing CIRCUITRACE®, GRIDTRACE™, waveforms, voltages and stage identification.

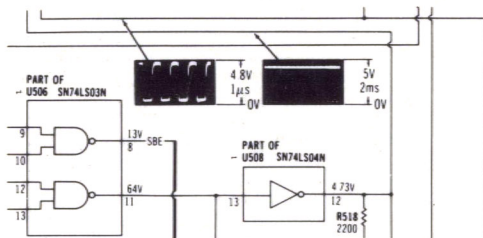

- Step by Step Troubleshooting guides the technician through the necessary procedures to quickly locate the problem.

TROUBLESHOOTING

MICROPROCESSOR CHIP (CPU) OPERATION

Verify the processor is functioning by checking the signals on the address lines (pins 10 thru 24 of IC U600) and the data lines (pins 41 thru 56) using a logic probe or a scope if a logic probe is used, refer to the "Logic Chart" for the correct readings. If a scope is used, the waveforms on the address lines (except pins 22 and 23 which have no signal in Power Up mode) should be similar to Figure 1. The waveforms on the data lines should be similar to Figure 2.

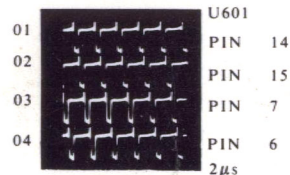

- Logic Chart containing logic probe readings to isolate defective circuitry and components.

LOGIC

PIN NO.	IC U100	PIN NO.	IC U100	PIN NO.	IC U102	IC U103	IC U104	IC U105	IC U106	IC U107	IC U108	IC U109
1	P	21	P	1	L	L	L	L	L	L	L	L
2	P	22	P	2	P	P	P	P	P	P	P	P
3	P	23	P	3	H	H	H	H	H	H	H	H

- Quick Component Location using the SAMS exclusive GRIDTRACE, CIRCUITRACE, and component photographs.

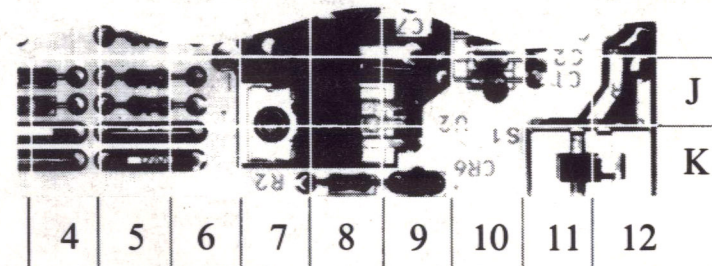

- Complete Components Parts List in an easy to use format with field replacements shown when possible. SAMS unique semiconductor, chip and IC cross-reference gives you many replacements to choose from and is available at your Electronic Distributor.

SEMICONDUCTORS (Select replacement for best results)

ITEM No.	TYPE No.	MFR. Part No.	ECG Part No.	NTE Part No.	REPLACEMENT DATA		NOTES
					RCA Part No.	ZENITH Part No.	
D102	1SS53	1149-2576	ECG519	NTE519	SK9091/177	103-131	
D103	2N60FM	1149-2527	ECG109	NTE109	SK3088	103-Z9001	
D201	1N4004GP	1201-4205	ECG116	NTE116	SK3312	212-76-02	
D501 thru D503	1SS53	1149-2576	ECG519	NTE519	SK9091/177	103-131	

CIRCUITRACE is a registered trademark of Howard W. Sams & Co. COMPUTERFACTS and GRIDTRACE are trademarks of Howard W. Sams & Co. Apple is a registered trademark of Apple Computer Inc.

To order, or for more information see your Sams Distributor, or telephone 800-428-SAMS.



HOWARD W. SAMS & COMPANY

A Division of Macmillan, Inc.

4300 West 62nd Street

Indianapolis, Indiana 46268 USA

INTEGRATED CIRCUITS-TTL

4-BY-4 REGISTER FILE, OPEN COLLECTOR OUTPUT
16-LEAD DIP, SEE DIAG 249

NTE74170, NTE74LS170

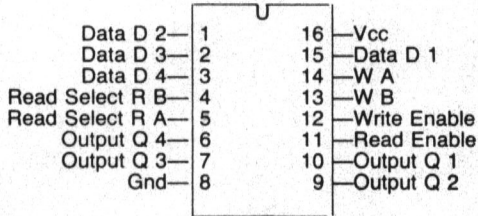

4-BIT D-TYPE FLIP-FLOP W/3-STATE OUTPUTS
16-LEAD DIP, SEE DIAG 249

NTE74173, NTE74LS173A

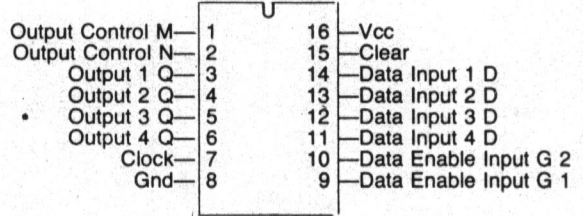

4-BIT D-TYPE FLIP-FLOP W/3-STATE OUTPUTS
16-LEAD DIP, SEE DIAG 249

NTE74C173

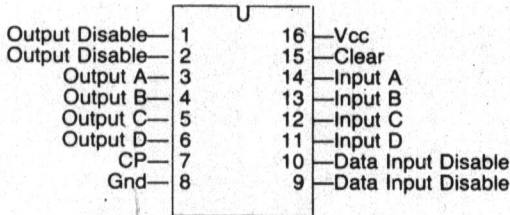

HEX D-TYPE FLIP-FLOP W/SERIAL RAILOUTPUTS AND COMMON DIRECT CLEAR
16-LEAD DIP, SEE DIAG 249

NTE74174, NTE74C174
NTE74LS174, NTE74S174

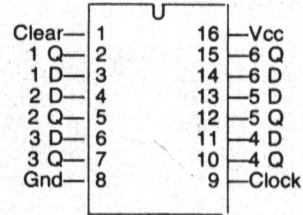

QUAD D-TYPE FLIP-FLOP W/COMMON DIRECT CLEAR AND COMPLEMENTARY OUTPUTS
16-LEAD DIP, SEE DIAG 249

NTE74175, NTE74C175
NTE74LS175, NTE74S175

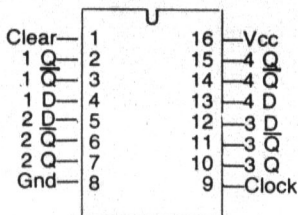

PRESETTABLE COUNTER/LATCH
14-LEAD DIP, SEE DIAG 247

NTE74176 (Decade)
NTE74177 (Binary)

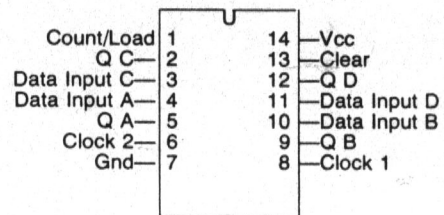

UNIVERSAL SHIFT REGISTER
14-LEAD DIP, SEE DIAG 247

NTE74178

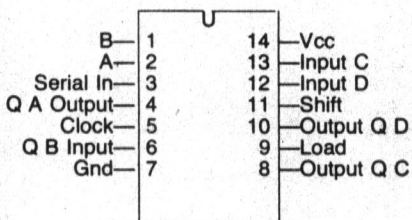

4-BIT UNIVERSAL SHIFT REGISTER W/DIRECT CLEAR
16-LEAD DIP, SEE DIAG 249

NTE74179

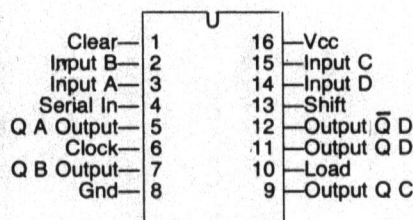

9-BIT ODD/EVEN PARITY GENERATOR/CHECKER
14-LEAD DIP, SEE DIAG 247

NTE74180

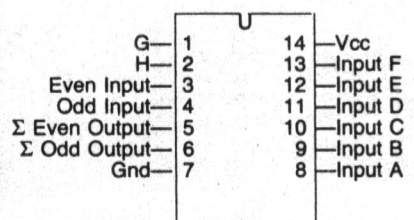

INTEGRATED CIRCUITS-TTL

8-LINE-TO-3-LINE OCTAL, PRIORITY ENCODER
16-LEAD DIP, SEE DIAG 249

NTE74148
NTE74LS148

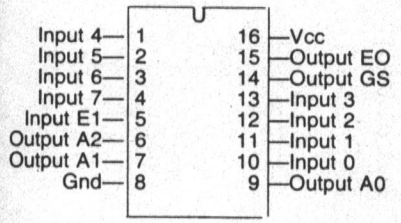

1-OF-16 DATA SELECTOR/MULTIPLEXER
24-LEAD DIP, SEE DIAG 252

NTE74150

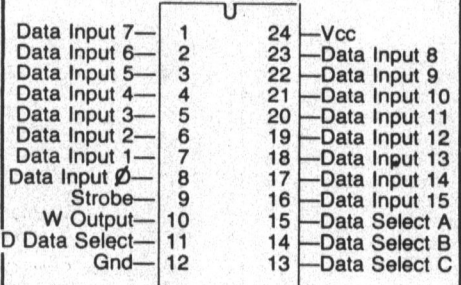

1-OF-8 DATA SELECTOR/MULTIPLEXER
16-LEAD DIP, SEE DIAG 249

NTE74C151

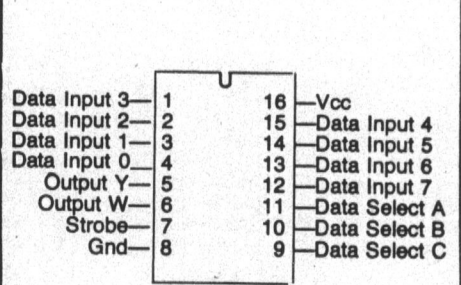

1-OF-8 DATA SELECTOR/MULTIPLEXER
16-LEAD DIP, SEE DIAG 249

NTE74151
NTE74LS151
NTE74S151

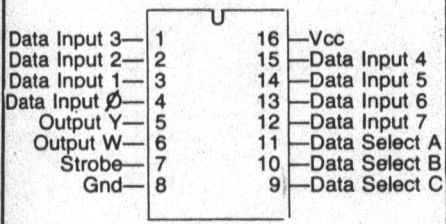

1-OF-8 DATA SELECTOR/MULTIPLEXER
14-LEAD DIP, SEE DIAG 247

NTE74152

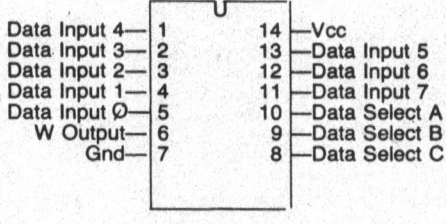

DUAL 4-LINE-TO-1-LINE DATA SELECTOR/MULTIPLEXOR
16-LEAD DIP, SEE DIAG 249

NTE74153
NTE74LS153
NTE74S153

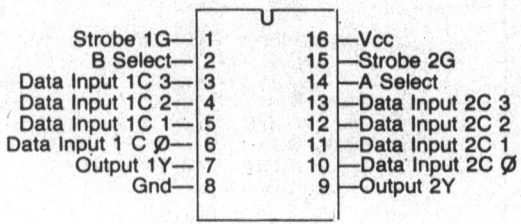

4-LINE-TO-16-LINE DECODER/DEMULTIPLEXER
24-LEAD DIP, SEE DIAG 252

NTE74154, NTE74C154

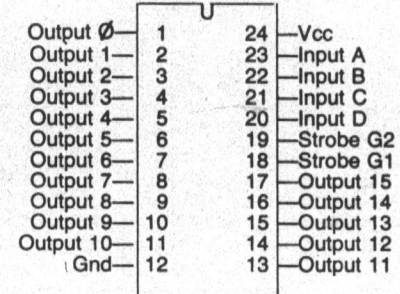

DUAL 2-LINE-TO-4-LINE DECODER/DEMULTIPLEXER W/TOTEM POLE OUTPUTS
16-LEAD DIP, SEE DIAG 249

NTE74155, NTE74LS155
NTE74156, NTE74LS156*

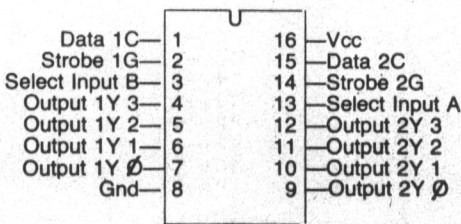

*74156, 74LS156 Have Open Collector Outputs

QUAD 2-LINE-TO-1-LINE DATA SELECTOR/MULTIPLEXER W/INVERTED DATA OUTPUTS
16-LEAD DIP, SEE DIAG 249

NTE74158
NTE74LS158, NTE74S158

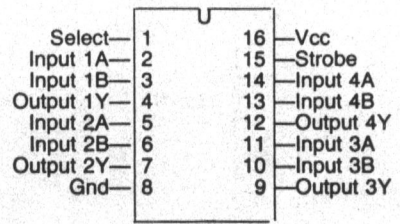

INTEGRATED CIRCUITS-TTL

QUAD 2-TO-1-LINE DATA SELECTOR/MULTIPLEXER W/NON INVERTED DATA OUTPUTS 16-LEAD DIP, SEE DIAG 249

**NTE74157, NTE74C157,
NTE74LS157, NTE74S157,**

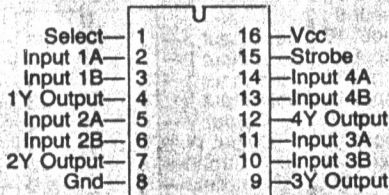

SYNCHRONOUS 4-BIT COUNTER 16-LEAD DIP, SEE DIAG 249

**NTE74180, NTE74C180, NTE74LS180A
NTE74181, NTE74C181, NTE74LS181A
NTE74182, NTE74LS182A,
NTE74LS183A, NTE74S183**

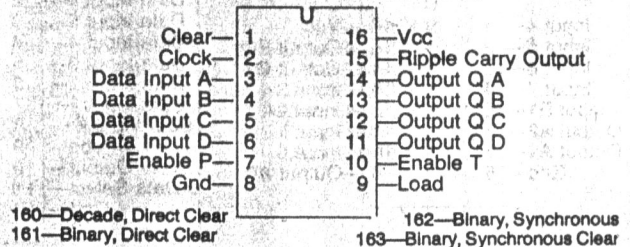

8-BIT PARALLEL-OUT SERIAL SHIFT REGISTER W/ASYNC CLEAR 14-LEAD DIP, SEE DIAG 247

NTE74164, NTE74C164, NTE74LS164

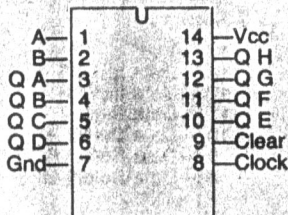

PARALLEL-LOAD 8-BIT SHIFT REGISTER W/COMPLEMENTARY OUTPUTS 16-LEAD DIP, SEE DIAG 249

NTE74165

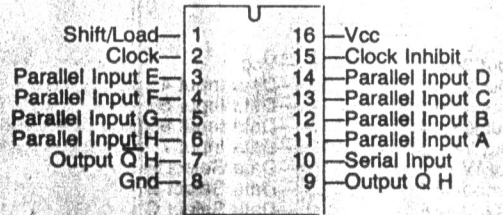

8-BIT PARALLEL-TO-SERIAL CONVERTER 16-LEAD DIP, SEE DIAG 249

NTE74LS166

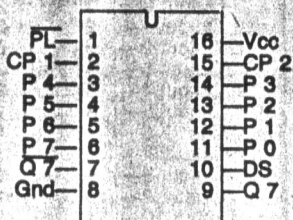

8-BIT PARALLEL OR SERIAL IN-SERIAL OUT SHIFT REGISTER 16-LEAD DIP, SEE DIAG 249

NTE74166, NTE74LS166

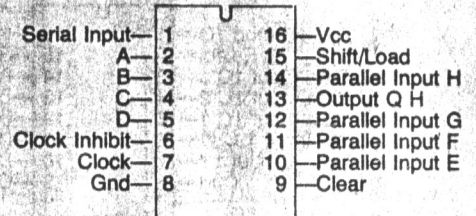

SYNCHRONOUS PRESETTABLE BCD DECADE UP/DOWN COUNTER 16-LEAD DIP, SEE DIAG 249

NTE74LS168A

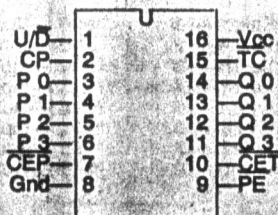

SYNCHRONOUS PRESETTABLE MODULO 16 COUNTER 16-LEAD DIP, SEE DIAG 249

NTE74LS169A

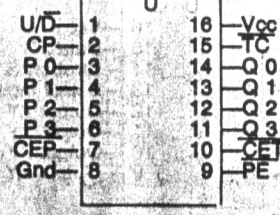

Apple II: Revisions 0,1,2,3,4,7,RF1
 Apple II plus: Revisions 7,RF1

CC 1 APPLE MODELS II,II PLUS



APPLE
MODELS II,II PLUS
CC 1

MODEL Apple II, Revision RF1

SAFETY PRECAUTIONS

See page 27.

INDEX

	Page		Page
Adjustments	14	Photos	
Block Diagram	32	Encoder Board	29
Diassembly Instructions	24,25	Logic (Main) Board	9,10,28
General Operating Instructions	12	Power Supply	6,31
GridTrace Location Guide		Safety Precautions	27
Encoder Board	8	Schematics	
Logic (Main) Board	8	Alt. Keyboard w/Encoder & Numeric	
IC Pinouts	11,26	Keypad	4,33
Legends		Encoder Board	2,7
IC Pinout Definitions	27	Keyboard	2
Line Definitions	14	Logic (Main) Board	2,3,5,34,35,36,37
Logic Chart	20 thru 23	Notes	11
Parts List	15 thru 20	Power Supply	7,30
		Terminal Guides	11,26
		Troubleshooting	12,13,14

SAMS™ Howard W. Sams & Co., Inc.
 4300 West 62nd Street, P.O. Box 7092, Indianapolis, Indiana 46206 U.S.A.

The listing of any available replacement part herein does not constitute in any case a recommendation, warranty or guaranty by Howard W. Sams & Co., Inc., as to the quality and suitability of such replacement part. The numbers of these parts have been compiled from information furnished to Howard W. Sams & Co., Inc., by the manufacturers of the particular type of replacement part listed.

Reproduction or use, without express permission, of editorial or pictorial content, in any manner, is prohibited. No patent liability is assumed with respect to the use of the information contained herein.

© 1984 Howard W. Sams & Co., Inc.
 4300 West 62nd Street, P.O. Box 7092, Indianapolis, Indiana 46206 U.S.A.
 Printed in U.S. of America. **83CF14900** **DATE 4-84**



SEE ALTERNATE KEYBOARD
AND NUMERIC PAD PAGE 4

PART OF ENCODER BOARD

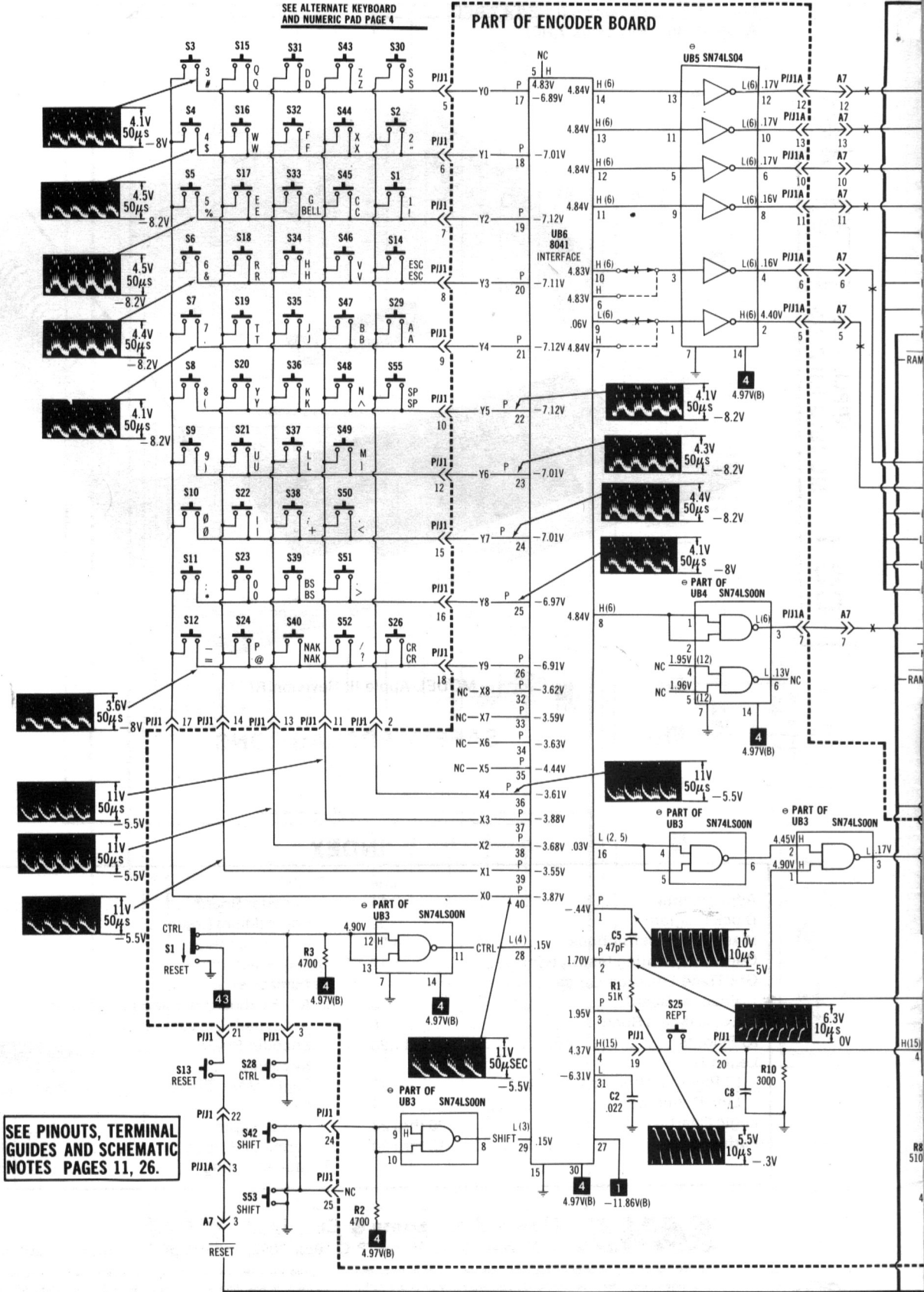

SEE PINOUTS, TERMINAL
GUIDES AND SCHEMATIC
NOTES PAGES 11, 26.

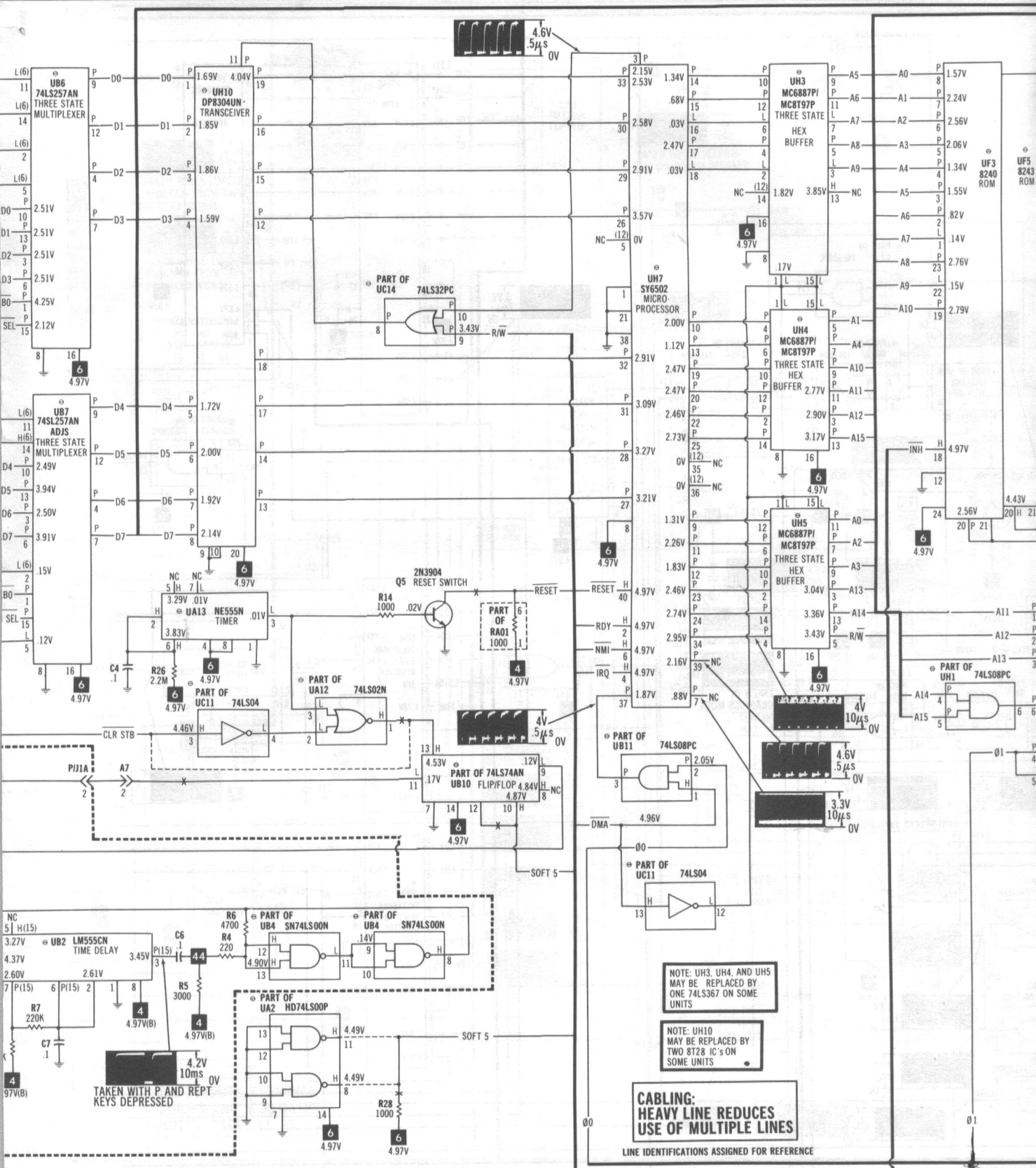

NOTE: UH3, UH4, AND UH5
MAY BE REPLACED BY
ONE 74LS367 ON SOME
UNITS

NOTE: UH10
MAY BE REPLACED BY
TWO 8T28 IC'S ON
SOME UNITS

**CABLING:
HEAVY LINE REDUCES
USE OF MULTIPLE LINES**

LINE IDENTIFICATIONS ASSIGNED FOR REFERENCE

SEE LINE DEFINITION

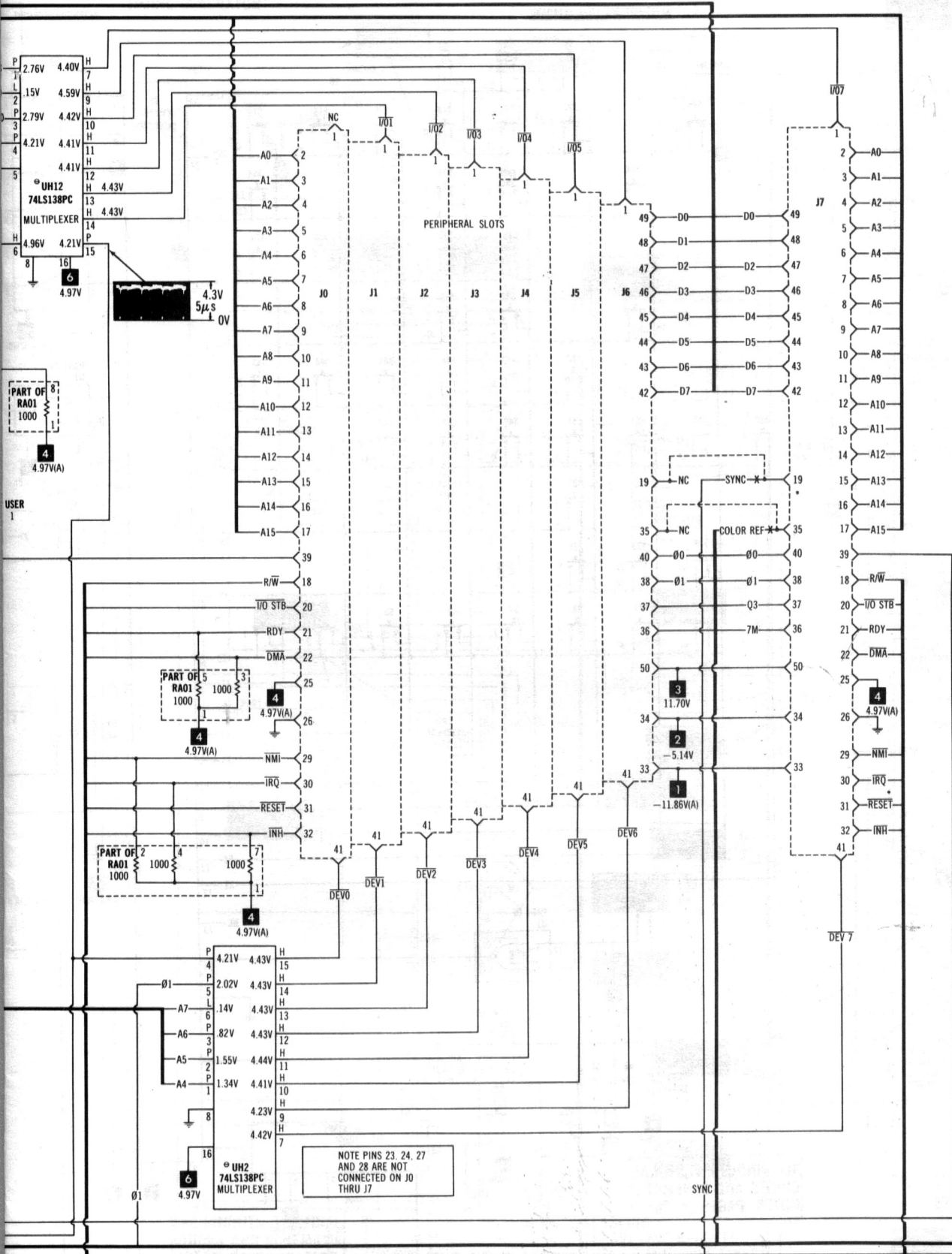

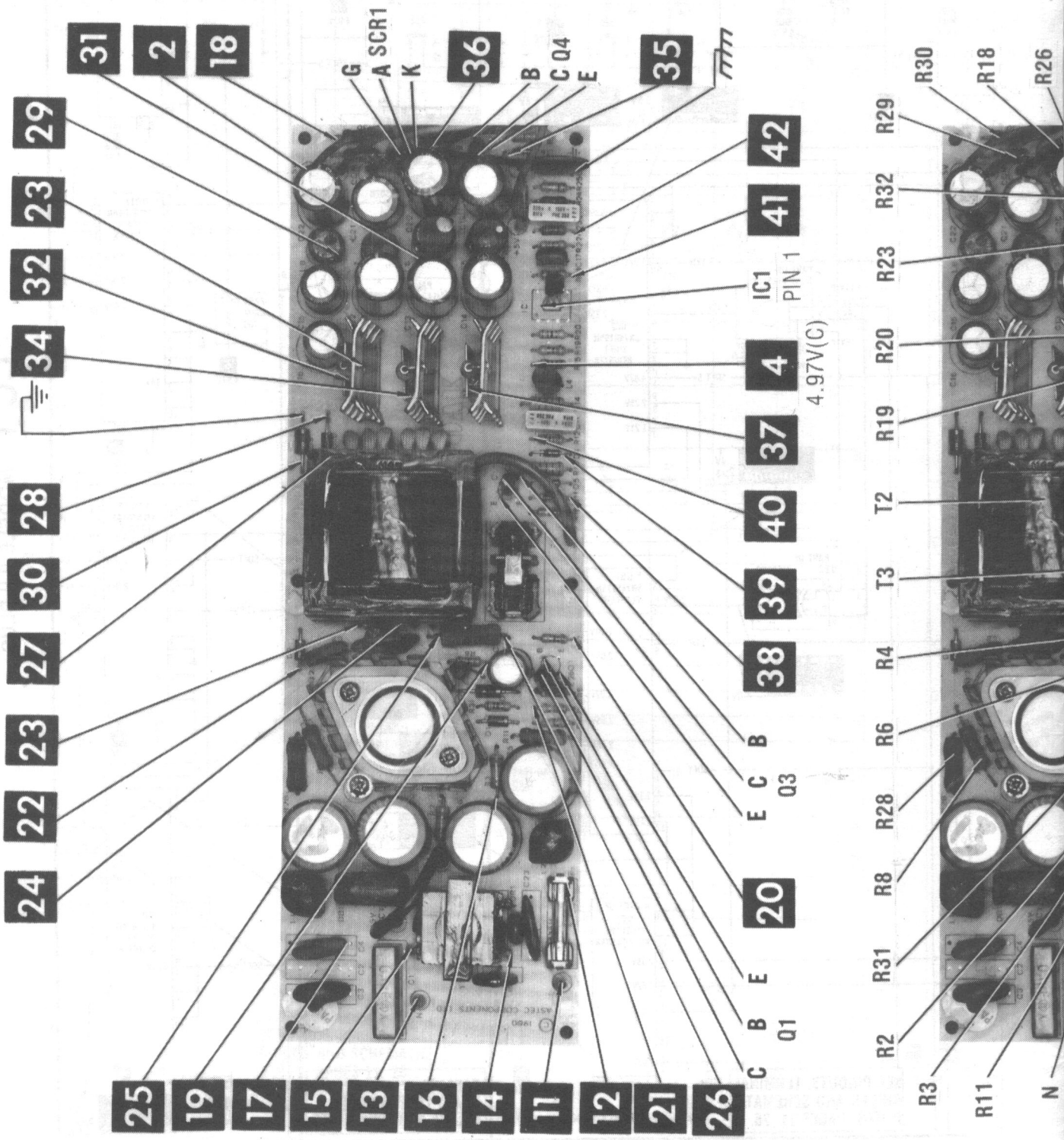

POWER SUPPLY BOARD

A Howard W. Sams CIRCUITRACE® Photo

LOGIC (MAIN) BOARD GridTrace LOCATION GUIDE

ENCODER BOARD GridTrace LOCATION GUIDE

A7	A-7	C73	D-9	R29	J-14	UF13	F-13	C1	B-6
B15	B-15	C74	D-11	R30	K-13	UF14	F-14	C2	B-6
C1	A-1	C75	D-15	R31	D-1	UH1	H-1	C3	B-6
C2	H-15	C76	C-15	R32	D-1	UH2	H-2	C4	B-6
C3	F-15	C77	C-9	UA2	A-2	UH3	H-3	C5	B-6
C4	A-13	C78	C-8	UA3	A-3	UH4	H-4	C6	B-1
C5	J-13	C79	C-7	UA5	A-5	UH5	H-5	C7	B-1
C6	J-13	C80	B-7	UA8	A-8	UH7	H-7	C8	A-5
C7	J-13	C81	C-5	UA9	A-9	UH10	H-10	J1	A-5
C8	J-13	C82	C-4	UA10	A-10	UH12	H-12	J1A	B-1
C9	H-13	C83	C-3	UA11	A-11	UH13	H-13	R1	B-6
C10	K-13	C84	B-1	UA12	A-12	UH14	H-14	R2	A-6
C11	J-14	C85	B-15	UA13	A-13	UJ1	J-1	R3	B-2
C12	B-14	C86	A-15	UA14	A-14	UJ3	J-13	R4	B-2
C13	K-15	C90	A-1	UB1	B-1	UK13	K-13	R5	B-1
C14	K-15	C91	E-5	UB2	B-2	XT001	A-1	R6	B-4
C15	B-3	C92	A-1	UB3	B-3			R7	A-1
C16	K-15	CR	J-14	UB4	B-4			R8	B-2
C17	K-1	J0	J-2	UB5	B-5			R10	B-1
C18	K-3	J1	J-4	UB6	B-6			S1	A-1
C19	K-4	J2	J-5	UB7	B-7			UB2	B-2
C20	K-6	J3	J-6	UB8	B-8			UB3	B-3
C21	K-7	J4	J-8	UB9	B-9			UB4	B-4
C22	K-8	J5	J-9	UB10	B-10			UB5	B-5
C23	K-10	J6	J-11	UB11	B-11			UB6	B-6
C24	K-11	J7	J-12	UB12	B-12				
C25	K-11	J14	J-14	UB13	B-13				
C26	J-1	J14A	J-15	UB14	B-14				
C27	J-3	J14B	R-15	UC1	C-1				
C28	J-4	K1	K-1	UC2	C-2				
C29	J-6	K13	K-13	UC3	C-3				
C30	J-7	K13A	K-13	UC4	C-4				
C31	J-8	K14	K-14	UC5	C-5				
C32	J-10	L1	H-15	UC6	C-6				
C33	J-11	L2	E-6	UC7	C-7				
C34	K-5	L3	J-2	UC8	C-8				
C35	K-11	L4	J-1	UC9	C-9				
C36	K-3	L5	J-1	UC10	C-10				
C37	K-7	L6	K-13	UC11	C-11				
C38	J-15	L7	K-14	UC12	C-12				
C39	E-1	Q1	A-1	UC13	C-13				
C40	D-1	Q2	A-1	UC14	C-14				
C41	C-1	Q3	J-15	UD2	D-2				
C42	K-3	Q4	J-14	UD3	D-3				
C43	K-6	Q5	A-13	UD4	D-4				
C44	K-7	Q6	F-13	UD5	D-5				
C45	K-8	R1	A-1	UD6	D-6				
C46	K-10	R2	A-1	UD7	D-7				
C47	K-5	R3	A-1	UD8	D-8				
C48	K-6	R4	A-1	UD9	D-9				
C49	K-8	R5	F-15	UD10	D-10				
C50	K-10	R6	J-15	UD11	D-11				
C51	K-11	R7	J-15	UD12	D-12				
C52	K-2	R8	J-15	UD13	D-13				
C53	K-2	R9	J-15	UD14	D-14				
C54	H-2	R10	K-14	UE3	E-3				
C55	H-15	R11	J-15	UE4	E-4				
C56	F-15	R12	B-3	UE5	E-5				
C57	F-2	R13	B-3	UE6	E-6				
C58	E-3	R14	A-13	UE7	E-7				
C59	E-4	R15	K-13	UE8	E-8				
C60	E-5	R16	J-13	UE9	E-9				
C61	D-5	R17	K-13	UE10	E-10				
C62	D-7	R18	K-14	UE11	E-11				
C63	E-8	R19	J-13	UE12	E-12				
C64	E-9	R20	J-13	UE13	E-13				
C65	E-11	R21	J-13	UE14	E-14				
C66	E-15	R22	J-13	UF2	F-2				
C67	D-3	R23	J-13	UF3	F-3				
C68	D-4	R24	J-14	UF5	F-5				
C69	D-5	R25	B-14	UF6	F-6				
C70	C-5	R26	A-13	UF8	F-8				
C71	D-7	R27	F-14	UF11	F-11				
C72	D-8	R28	B-3	UF12	F-12				

LOGIC (MAIN) BOARD

A Howard W. Sams CIRCUITRACE Photo

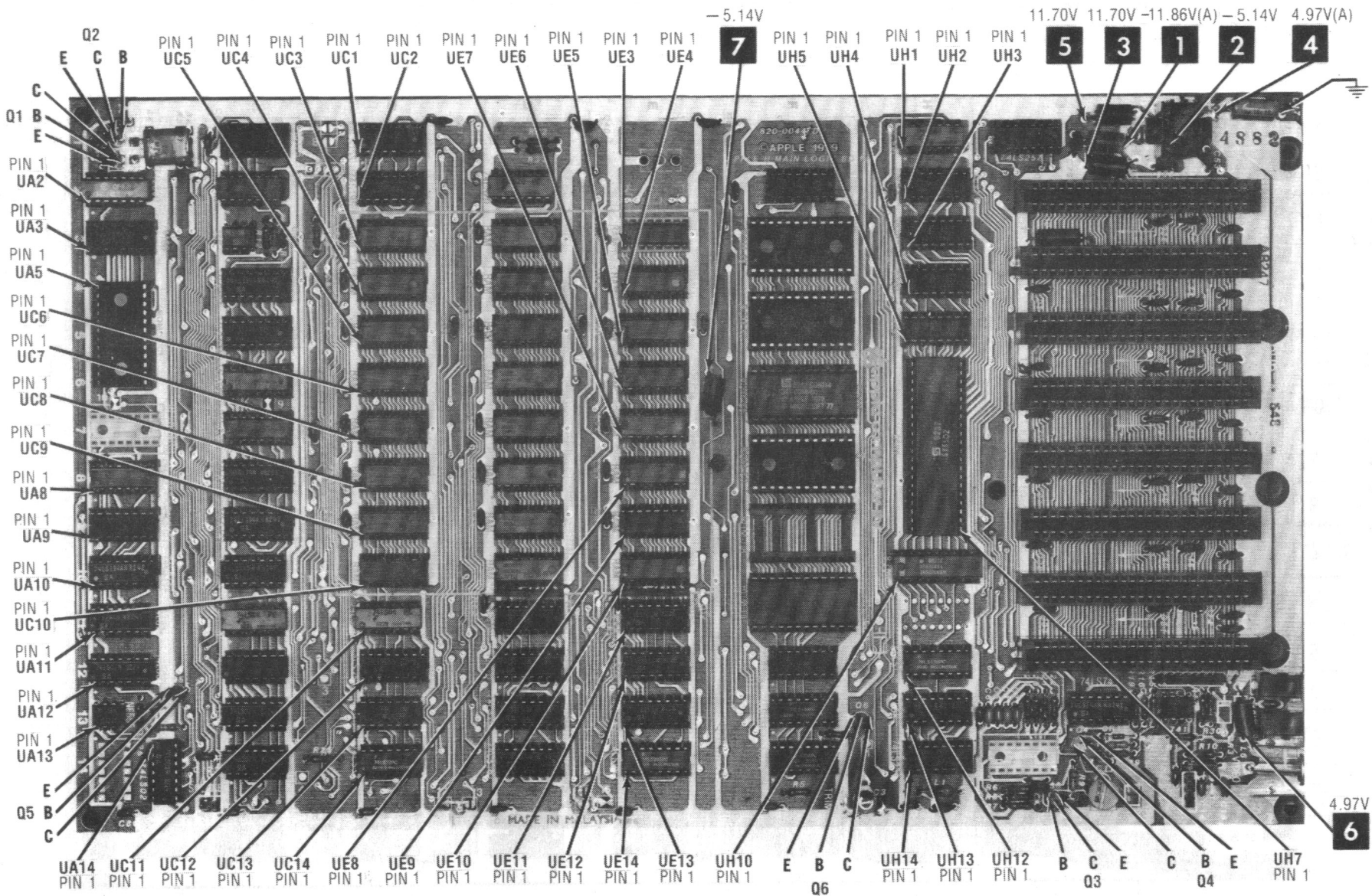

UIDES & SCHEMATIC NOTES

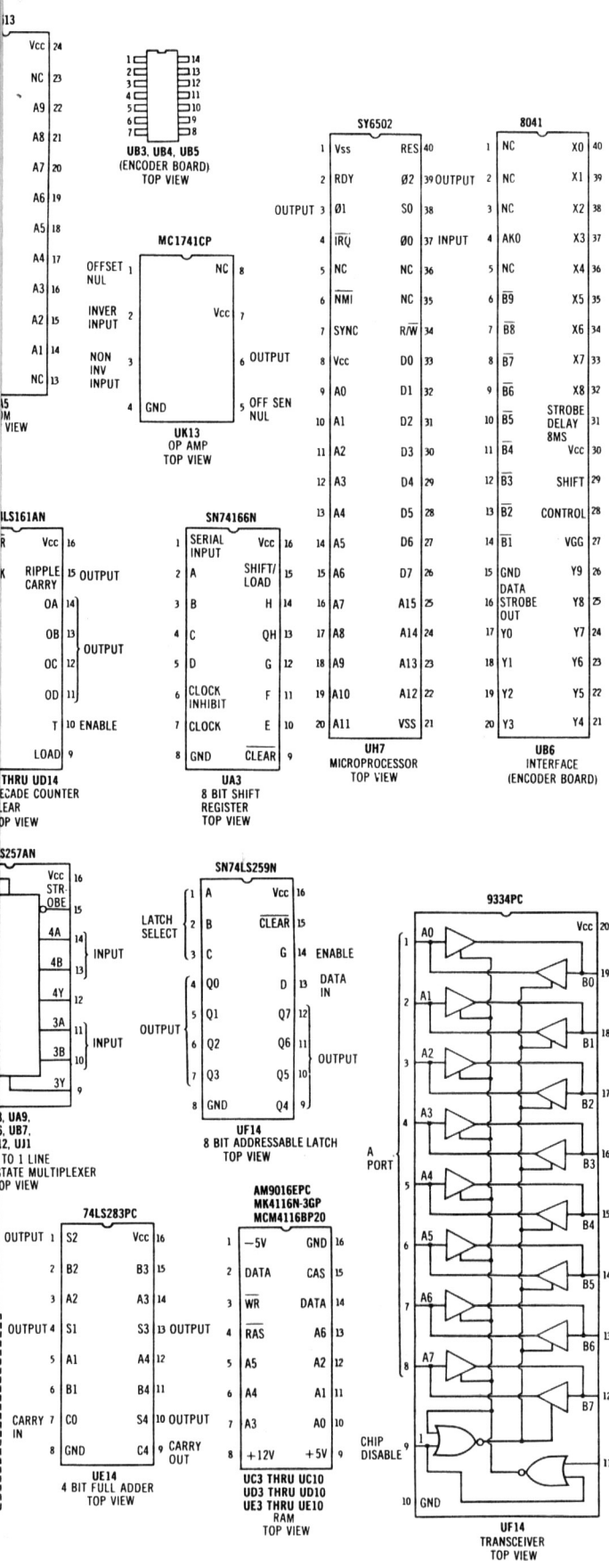

SCHEMATIC NOTES

- ✖ Circuitry not used in some versions
- Circuitry used in some versions
- ⊕ See parts list
- ⊛ Nominal value
- ⊥ Ground

Item numbers in rectangles appear in the alignment/adjustment instructions.
 Supply voltages maintained as shown at input.
 Voltages measured with digital meter.
 Terminal identification may not be found on unit.

Voltages and Waveforms taken with Integer Basic in ROM and in Monitor mode unless noted. Waveforms taken with triggered scope and Sweep/Time switch in Calibrate position, scope input set for DC coupling on "0" reference voltage waveforms. Switch to AC input to view waveforms after DC reference is measured when necessary. Each waveform is 9 cm width with DC reference voltage given at the bottom line of each waveform. Time in μ sec. per cm, given with p-p reading at the end of each waveform.

Resistors are 1/2W or less, 5% unless noted.
 Value in () used in some versions.

NOTE: Logic probe readings taken after just turning computer on (power-up) unless otherwise noted. Unit with integer BASIC in ROM and without Auto-start ROM used for logic probe readings.

- NOTE: RFI Revision with computer in Monitor mode.
- (1) Reading goes high when a key is pressed.
 - (2) SHIFT, CTRL, REPT and RESET keys have no effect.
 - (3) Reading goes high when SHIFT key is pressed.
 - (4) Reading goes high when CTRL key is pressed.
 - (5) Probe will show a pulse when a key is pressed.
 - (6) Measured after pressing SPACE BAR on keyboard.
 - (7) Low in Graphics mode.
 - (8) Probe will show P while Loading a program from tape.
 - (9) Probe will show P while Saving a program on tape.
 - (10) Probe will show P while beeping the on-board speaker.
 - (11) Probe will show H while Loading a program from tape.
 - (12) Open.
 - (13) Used only with Apple II plus.
 - (14) With Auto-start ROM.
 - (15) Readings taken with P and REPT keys depressed.

Logic Probe display
 L = Low
 H = High
 P = Pulse

GENERAL OPERATING INSTRUCTIONS

POWER UP

The computer will come up in Basic mode when turned on if it has an Auto-start ROM. The unit will come up in Monitor mode with an * in the lower left corner of screen if it does not have an Auto-start ROM.

FROM MONITOR TO BASIC

Hold down the CTRL key and type C, then press RETURN key (any Basic program in memory, before going to Monitor mode, will remain in memory).

Hold down the CTRL key and type B, then press RETURN key (any Basic program in memory will be lost).

FROM BASIC TO MONITOR

Type CALL-151 and press RETURN key.

RESET BUTTON

On some models the operation of the RESET key depends on the position of CTRL/Reset Switch (S1) located on top left side of the keyboard encoder board. If Switch (S1) is in CTRL position, the CTRL and RESET keys must be pressed at the same time. If Switch (S1) is in Reset position, the RESET key functions without the CTRL key.

BOOTING THE DISK OPERATING SYSTEM (DOS)

Insert an initialized disk (diskette) containing DOS into disk drive number 1. If the unit is equipped with an Auto-start ROM, it will boot automatically when turned on and come up in Basic mode. If the unit does not have an Auto-start ROM, it will come up in Monitor mode when turned on. Type C600G and press RETURN to boot from Monitor mode, or type 6 CTRL P and press RETURN (press the CTRL key while typing P).

To boot from Basic, type PR #6 or IN #6 and press RETURN. If there is no disk in the

drive, the drive can be stopped by pressing the RESET key or CTRL and RESET keys on some models.

OPERATING THE DISK SYSTEM

(Basic Mode Only)

Type CATALOG and press RETURN key to get a list of programs on the disk.

Type LOAD and program name, press RETURN key to load a program from disk.

Type SAVE and program name, press RETURN key to save a program on disk.

The type of data saved on a disk is identified by the first letter on each program in the catalog (A=Applesoft, I=Integer, B=Binary, T=Text, R=Relocatable binary).

A blank disk must be initialized before it will function. To initialize a disk, boot the disk operating system from a disk containing DOS and put the blank disk in the drive. Type INIT HELLO and press RETURN. The disk will be initialized when the drive stops.

CASSETTE OPERATION

Connect the microphone cable from the recorder to the Cassette Out jack on the computer.

Connect the speaker cable from the recorder to the Cassette In jack on the computer.

To Save a Basic program put the recorder in Record mode, type SAVE and press the RETURN key. The program has been saved when the second beep is heard.

To Load a Basic program set the tone control to the high end and adjust the volume to just audible. Type LOAD and press RETURN. Set the cassette to the beginning of the program and press the PLAY button on the recorder. When second beep is heard, the program has been loaded.

TROUBLESHOOTING

MICROPROCESSOR CHIP (CPU) OPERATION

Verify the processor is working by checking the signals on the address lines (pins 9 thru 20 and 22 thru 25) and the data lines (pins 26 thru 33) with a logic probe or a scope. If a logic probe is used, it should show pulses on all pins except pins 16 and 18 which will read low when the computer is first turned on. To verify the operation of pins 16 and 18, connect the logic probe to the pin being checked and press the RETURN key. The logic probe should indicate pulses when the RETURN key is pressed. If a scope is used, the waveforms on the address lines, except for pins 16 and 18, should be similar to Figure 1. The waveforms on the data lines should be similar to Figure 2.

CRYSTAL OSCILLATOR

Connect a frequency counter to pin 10 of IC (UB2) to check the frequency of the oscillator. The counter should read 14.31818MHz.

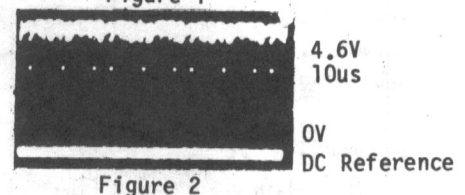
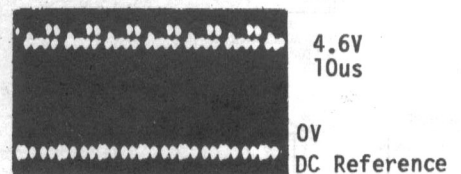

OSCILLATOR DIVIDERS

Check the operation of the frequency divider IC's by checking the waveforms on pin 3 of IC (UA2), pins 2, 3, 6, 7, 14 and 15 of IC (UB1), pin 8 of IC (UB2) and pins 12 thru 15 of IC (UC2).

TROUBLESHOOTING (Continued)

VIDEO SIGNALS

LUMINANCE: Verify the operation of the luminance part of the video by checking the waveform at pin 5 of IC (UB10).

SYNC: Verify the operation of the sync circuits by checking the waveform at pin 8 of IC (UC13).

COLOR: Verify the operation of the color circuits by checking the waveform at pin 12 of IC (UB12). Note: The computer must be in Graphics mode to get a color signal.

PERIPHERAL I/O SLOTS

To verify the operation of the seven I/O slots, check pin 1 of each slot. Type PR# and the number of the slot being checked. Check for waveform shown in Figure 3 by connecting scope to pin 1 of the respective I/O slot.

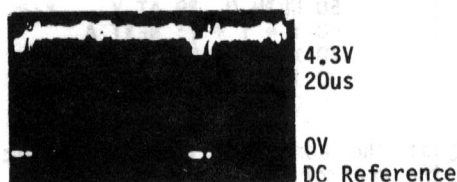

Figure 3.

CHECKING ROM AND RAM CHIP SELECT LINES

Turn on the computer and select the Monitor mode. See "General Operating Instructions". The chip select lines for the ROM at pins 20 & 21 of IC (UF8) and RAM at pin 15 of IC (UE3 thru UE10) should now show pulses on a logic probe. To check the rest of the chip select lines, use the chart below. Type the number given in the Enter column, press the RETURN key and check the pin number given for the IC's listed with a logic probe.

NOTE: If the Disk Operating System has been loaded into RAM, IC's (UE3 thru UE10) will show pulses on pin 15 while IC's (UD3 thru UD10) are being checked.

ENTER	IC	PIN NUMBER
4000.7FFF	UD3 thru UD10	15
8000.BFFF	UE3 thru UE10	15
D000.D7FF	ROM UD0	20,21
D800.DFFF	ROM UD8	20,21
E000.E7FF	ROM UE0	20,21
E800.EFFF	ROM UE8	20,21
F000.F7FF	ROM UF0	20,21

CHECKING SOFTWARE SWITCHES FOR TEXT, GRAPHICS AND GAME I/O

Check the software switches using the following table and a logic probe. If the computer is in Monitor mode, type the hex number found in the Monitor column and press the RETURN key. If the computer is in Basic mode, type the word PEEK, then type (within parentheses) the number found in the Basic column and press the RETURN key. The logic probe should read the same as the reading found in the Logic Probe column.

	UF14 PIN	MONITOR	BASIC	LOGIC PROBE
GRAPHICS OR TEXT AND GRAPHICS	4	C050	-16304	L
ALL TEXT	4	C051	-16303	L
ALL GRAPHICS OR ALL TEXT	5	C052	-16302	L
TEXT AND GRAPHICS	5	C053	-16301	H
SELECT PAGE 1	6	C054	-16300	L
SELECT PAGE 2	6	C055	-16299	H
SELECT LO-RES	7	C056	-16298	L
SELECT HI-RES	7	C057	-16297	H
GAME CONTROL OUTPUT D	9	C058	-16296	L
GAME CONTROL OUTPUT 0	9	C059	-16295	H
GAME CONTROL OUTPUT 1	10	C05A	-16294	L
GAME CONTROL OUTPUT 1	10	C05B	-16293	H
GAME CONTROL OUTPUT 2	11	C05C	-16292	L
GAME CONTROL OUTPUT 2	11	C05D	-16291	H
GAME CONTROL OUTPUT 3	12	C05E	-16290	L
GAME CONTROL OUTPUT 3	12	C05F	-16289	H

CHECKING INPUTS FOR GAME SWITCHES

To use software to check the input circuits for the game switches, type in the following Basic program. Using the chart, connect the input pin listed under J14 Pin Number column to be checked to the point listed under Connect To column. Run the program and type in the number given in the Address column and press the RETURN key. If the input pin being checked is connected to ground, the program should print out X = 127 (or less). If the input pin is connected to 5V the program should print out X = 128 (or more).

```

10 PRINT "ADDRESS = ";
20 INPUT Y
30 X = PEEK (Y)
40 PRINT "X = ";X
50 GOTO 10
    
```

SWITCH	J14 PIN NUMBER	CONNECT TO	ADDRESS
SW0	2	Ground (J14 Pin 8)	-16287
SW0	2	5V (J14 Pin 1)	-16287
SW1	3	Ground	-16286
SW1	3	5V	-16286
SW2	4	Ground	-16285
SW2	4	5V	-16285

CHECKING GAME PADDLE TIMERS

Connect game paddles to the timers to be checked, or connect a 150K ohm resistor from the paddle input to be checked (J14 pins 6, 10, 7 or 11) to +5V (J14 pin 3). Run the following program to trigger the timers and check for the waveform shown in Figure 4 at the timer output (UH13 pins 1, 16, 9, 8). If paddles are used the paddles should be set for Maximum resistance.

```

10 X = PEEK (-16272)
20 GOTO 10
    
```

OV
DC Reference

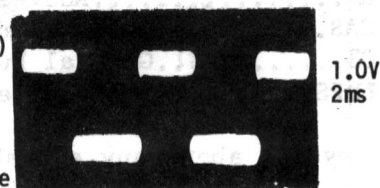

Figure 4

PARTS LIST AND DESCRIPTION

When ordering replacement parts from manufacturer, state Model/Serial/Revision Number, Item Number, Name and location of part.

SEMICONDUCTORS

ITEM No.	TYPE No.	MFGR. PART No.
LOGIC (MAIN) BOARD		
CR1	1N914	
Q1,2	2N4258	
Q3	2N3904	
Q4	MPSA13	
Q5,6	2N3904	
UA2	HD74LS00P 74LS00	(1)
UA3	SN74166N 74166	
UA5	2316B 2513	(1)
UA8	74LS257AN 74LS257	
UA9	AM25LS151PC 74LS151	(1)
UA10	74LS194AN 74LS194	
UA11	74LS74AN 74LS74PC 74LS74	(1)
UA12	74LS02N 74LS02	
UA13	NE555N 555	
UA14	74LS02N	(1)
UB1	SN74S175N 74S175PC 74S175	(1)
UB2	74S86PC DM74S86N 74S86	(1)
UB3	NE555N MC1455P1	(1)
UB4	SN74LS194AN SN74LS194 74LS194APC	(1)
UB5	74LS174N 74LS174PC 74LS174	(1)
UB6	74LS257AN DM74LS257N 74LS257	(1)
UB7	74SL257AN SN74LS257AJD S 74LS257	(1)
UB8	74LS174N DM74LS174N 74LS174	(1)
UB9	74SL194AN 74LS194APC 74LS194	(1)

ITEM No.	TYPE No.	MFGR. PART No.
UB10	74LS74AN DM74LS74N 74LS74	(1)
UB11	74LS08PC 74LS08	
UB12	DM74LS11N 74LS11PC 74LS11	(1)
UB13,14	74LS02N 74LS02	
UC1	74LS153N 74LS153PC 74LS153	(1)
UC2	SN74S195N 74S195A 74S195	(1)
UC3 Thru UC10	MK4116N-3GP UPD416C-2	(1)
UC11	74LS04 SN74LS04N	(1)
UC12	74LS257AN DM74LS257N 74LS257	(1)
UC13	SN74LS51N DM74LS51N 74LS51	(1)
UC14	74LS32PC 74LS32	
UD1		(2)
UD2	74LS20PC 74LS20	
UD3 Thru UD10	MK4116N-3GP MCM4116AC20	(1)
UD11	UPD4116C-2 74LS161AN SN74LS161AN 74LS161	(1)
UD12	74LS161AN 74LS161PC 74LS161	(1)
UD13	74LS161AN SN74LS161AN 74LS161	(1)
UD14	74LS161AN 74LS161PC 74LS161	
UE1		(2)
UE2	74LS139	(2)
UE3	4116	(1)

CC 1
APPLE
MODELS II, III PLUS

PARTS LIST AND DESCRIPTION (CONTINUED)

When ordering replacement parts from manufacturer, state Model/Serial/Revision Number, Item Number, Name and location of part.

SEMICONDUCTORS (cont)

ITEM No.	TYPE No.	MFGR. PART No.
UE4 Thru UE10 UE11	AM9016EPC MCM4116AC20 74LS153N 74LS153	(1)
UE12,13	74LS153N SN74LS153AN 74LS153	(1)
UE14	74LS283PC 74LS283	
UF1 UF2	SN74LS139N 74LS139PC 74LS139	(2) (1)
UF3	8240 8032RL	(1)
UF5	8243 8028SN	(1)
UF6	8242 8028TJ	(1)
UF8	8245 8028SP	(1)
UF9 UF11	8244 8244 8012BA	(1)
UF12	74LS138PC SN74LS138N 74LS138	(1)
UF13	74LS138PC 74LS138	
UF14	F9334PC SN74SL259N 74LS259	(1)
UH1	74LS08PC SN74LS08N 74LS08	(1)
UH2	74LS138PC 74LS138	
UH3	MC6887P/ MC8T97P N8T97N	(1) (3)
UH4	MC6887P/ MC8T97P N8T97N	(1) (3)
UH5	MC6887P/ MC8T97P N8T97N	(1) (3)
UH7	SY6502 6502	(1)
UH10	DP8304UN H8T28N 8T28	(1)
UH11	MC6889P/ MC8T28P 8T28	

ITEM No.	TYPE No.	MFGR. PART No.
UH12	74LS138PC SN74LS138N 74LS138	(1)
UH13 UH14	NE558N SN74LS251N 74LS251PC	(1)
UJ1	74LS257AN SN74LS257AJDS 74LS257	(1)
UJ13	74LS74AN M74LS74P 74LS74	(1)
UK13	MC1741CP MA741	
ENCODER BOARD		
UB2	LM555CN MC1455P1 1455	(1)
UB3,4	SN74LS00N 74LS00	
UB5	SN74LS04N 74LS04	
UB6	8041	
KEYBOARD w/ENCODER		
CR1	1N4148	(2)
Q7		(2)
U1		(2)
U2		(2)
U3	MC1455P1	(2)
U4		(2)
U5	MM5740	(2)
POWER SUPPLY		
D1	RGP15B	
D2,3	RGP10J	
D4,5	1N4606	
D6 Thru D8		
D9	RGP15B	
D10	RGP10J	
D11	1N4606	
D12	RGP15B	
DB1	KBP-10	
IC1	T18231	
Q1	2SD467C	
Q2		
Q3	2SB561B	
Q4	2SB561B	
SCR1	2N6395	
Z1		

(1) Used in all revisions except RF1.
(2) Used in some versions.

(3) Replace with single unit (74LS367) in some versions.

PARTS LIST AND DESCRIPTION (CONTINUED)

When ordering replacement parts from manufacturer, state Model/Serial/Revision Number, Item Number, Name and location of part.

CAPACITORS

ITEM No.	RATING	MFGR. PART No.
LOGIC (MAIN) BOARD		
C1	.1 50V	
C2	47 N470 50V 5%	
C3	Trimmer 5pF-50pF	
C4	.1 50V	
C5	.022 50V 10%	
C6	.022 50V 10%	
C7	.022 50V 10%	
C8	.022 50V 10%	
C9	.1 50V	
C10	.1 50V	
C11	.1 50V	
C12	.1 50V	
C13	.1 50V	
C14	.1 50V	
C15	.1 50V	
C16	47 N470 50V 5%	
C18	.001 50V	
C19	.001 50V	
C20	.001 50V	
C21	.001 50V	
C22	.001 50V	
C23	.001 50V	
C24	.001 50V	
C25	.001 50V	
C26	.001 50V	
C28	.001 50V	
C29	.001 50V	
C30	.001 50V	
C31	.001 50V	
C32	.001 50V	
C33	.001 50V	
C34	.001 50V	
C35	.001 50V	
C36	.001 50V	
C37	.001 50V	
C38	.001 50V	
C39	.001 50V	
C40	.001 50V	
C41	.001 50V	
C42	.001 50V	
C43	.001 50V	
C44	.001 50V	
C45	.001 50V	
C46	.001 50V	
C47	.001 50V	
C48	.001 50V	
C49	.001 50V	
C50	.001 50V	
C51	.001 50V	
C52	.001 50V	
C53	.001 50V	
C54	.1 50V	
C55	.1 50V	
C56	.1 50V	
C57	.1 50V	
C58	.1 50V	
C59	.1 50V	
C60	.1 50V	

ITEM No.	RATING	MFGR. PART No.
C61	.1 50V	
C62	.1 50V	
C63	.1 50V	
C64	.1 50V	
C65	.1 50V	
C66	.1 50V	
C67	.1 50V	
C68	.1 50V	
C69	.1 50V	
C70	.1 50V	
C71	.1 50V	
C72	.1 50V	
C73	.1 50V	
C74	.1 50V	
C75	.1 50V	
C76	.1 50V	
C77	.1 50V	
C78	.1 50V	
C79	.1 50V	
C80	.1 50V	
C81	.1 50V	
C82	.1 50V	
C83	.1 50V	
C84	.1 50V	
C85	.1 50V	
C86	.1 50V	
C90	.1 50V	
C91	.1 50V	
C92	.1 50V	
ENCODER BOARD		
C2	.022 50V	
C3	.1 50V	
C4	.1 50V	
C5	47 50V	
C6	.1 50V	
C7	.1 50V	
C8	.1 50V	
KEYBOARD w/ENCODER		
C2	.1	
C4	.001	
C6	.1	
POWER SUPPLY		
C1	.1 250V	
C3	.0022 400V	
C4	.0022 400V	
C8	470 3KV	
C9	.01 1KV	
C10	.01 1KV	
C11	.22 100V 10%	
C17	.022 50V 10%	
C18	.22 100V 10%	
C23	.01 1KV	
C26	.01 50V	

CC 1
APPLE
MODELS II, II PLUS

PARTS LIST AND DESCRIPTION (CONTINUED)

When ordering replacement parts from manufacturer, state Model/Serial/Revision Number, Item Number, Name and location of part.

ELECTROLYTIC CAPACITORS

ITEM No.	RATING	MFGR. PART No.
LOGIC (MAIN) BOARD		
C17	10 16V	
C27	10 16V 20%	
ENCODER BOARD		
C1	1 50V	
KEYBOARD w/ENCODER		
C7	1	

ITEM No.	RATING	MFGR. PART No.
POWER SUPPLY		
C5	47 250V	
C6	47 250V	
C7	220 10V 20%	
C12	1000 10V	
C13	1000 10V	
C14	1000 10V	
C15	220 10V	
C16	220 10V	
C19	1000 10V	
C20	680 16V	
C21	330 16V	
C22	330 16V	
C24	47 250V	
C25	47 250V	

CONTROLS (All wattages 1/2 watt, or less, unless listed)

ITEM NO.	FUNCTION	RESISTANCE	MFGR. PART NO.	NOTES
R11	Video	200		

RESISTORS (Power and Special)

ITEM No.	RATING
POWER SUPPLY	
R1	NTC 5 Cold
R23	2700 2% 1/4W Metal Film
R24	2700 2% 1/4W Metal Film
VDR1	VDR

ITEM No.	RATING
LOGIC (MAIN) BOARD	
RA01	Resistor Network 7X1K
RA02	Resistor Network 7X1K
RA03	Resistor Network 7X1K

COILS (RF-IF)

ITEM No.	FUNCTION	MFGR. PART No.
LOGIC (MAIN) BOARD		
L1	RF Choke	
L2	RF Choke	
L3	RF Choke	
L4	RF Choke	
L5	RF Choke	
L6	RF Choke	
L7	Peaking	

ITEM No.	FUNCTION	MFGR. PART No.
POWER SUPPLY		
L1	RF Choke	
L2	RF Choke	
L3	RF Choke	
L4	RF Choke	
L5	RF Choke	
L6	RF Choke	
L7	RF Choke	
L8	RF Choke	
T1	AC Line Choke	

COILS & TRANSFORMERS (Sweep Circuits)

ITEM No.	FUNCTION	REPLACEMENT DATA		
		MFGR. PART No.	OTHER IDENTIFICATION	THORDARSON PART No.
T2 T3	Switching Power Switching Driver			

PARTS LIST AND DESCRIPTION (CONTINUED)

When ordering replacement parts from manufacturer, state Model/Serial/Revision Number, Item Number, Name and location of part.

FUSE DEVICES

ITEM No.	DESCRIPTION	REPLACEMENT DATA				NOTES
		MFR. PART No.		BUSS PART No.		
		DEVICE	HOLDER	DEVICE	HOLDER	
F1	2.75A @ 125V Fast-Acting					

SPEAKER

ITEM No.	TYPE	REPLACEMENT DATA		NOTES
		MFR. PART No.	QUAM PART No.	
B14A	2 1/4" PM, 8 Ohms			

MISCELLANEOUS

ITEM No.	PART NAME	MFR. PART No.	NOTES
LOGIC (MAIN) BOARD			
K13	Jack		Cassette Data Input
K13A	Jack		Cassette Data Output
K14	Socket		Composite Video Output
S1, S1A	Switch		Part of Keyboard
S2	Switch		Part of Keyboard
Thru S26			
S28	Switch		Part of Keyboard
Thru S40			
S42	Switch		Part of Keyboard
Thru S53			
S55	Switch		Part of Keyboard
XT100	Crystal		Timing Oscillator
	P.C. Board		Logic (Main) Assembly
ENCODER BOARD			
	P.C. Board		Encoded Assembly
KEYBOARD w/ENCODER			
S1	Switch		Part of Keyboard
Thru S12			
S14	Switch		Part of Keyboard
Thru S26			
S24	Switch		Part of Keyboard
Thru S40			
S42	Switch		Part of Keyboard
Thru S53			
S55	P. C. BOARD		Part of Keyboard Keyboard w/Encoder
NUMERIC KEY PAD			
S0	Switch		Part of Numeric Pad
Thru S15			
	P.C. Board		Numeric Keyboard Pad
POWER SUPPLY			
P1/J2	Cord		AC Power
P2	Plug		AC Interlock
S1	Switch		AC Power On/Off

APPLE
MODELS II, II PLUS

PARTS LIST AND DESCRIPTION (CONTINUED)

When ordering replacement parts from manufacturer, state Model/Serial/Revision Number, Item Number, Name and location of part.

CABINETS & CABINET PARTS (When ordering specify model, chassis & color)

LOGIC (MAIN) BOARD

PIN NO.	IC UA2	IC UA3	IC UA5	IC UA8	IC UA9	IC UA10	IC UA11	IC UA12	IC UA13	IC UA14	IC UB1	IC UB2	IC UB3	IC UB4	IC UB5	IC UB6
1	P	P	P	H	P	H	L	H	L	L	H	P	L	H	H	P
2	P	P	P	P	P	H	H	L	L	H(7)	P	P	L	H	L	L(6)
3	P	L	P	P	P	L	H	L	L	P	P	P	P	P	L	P
4	P	P	P	P	P	P	L	P	H	P	P	H	H	P	P	P
5	P	P	P	P	P	P	H	P	H	P	P	P	H	P	P	L(6)
6	P	P	P	L	P	P	H	P	H	P	P	P	P	P	P	P
7	L	P	P	L	P	H	L	L	L	L	P	L	P	P	P	P
8	H	L	P	L	L	L	P	L	H	L	L	L	H	L	L	L
9	L	H	L	P	L	P	P	L		P	P	L		P	P	P
10	L	P	P	P	L	P	H	H		P	P	P		P	P	P
11	H	P	P	H	P	P	P	L		P	P	P		P	P	L(6)
12	L	P	L	P	P	P	P	H		P	P	P		P	P	P
13	L	P	P	P	P	P	H	L		P	P	P		P	P	P
14	H	L	P	P	P	L	H	H		H	P	H		P	P	L(6)
15		P	P	L	H	H					P			P	H	P
16		H	L	H	H	H					P			H	H	H
17			P													
18			L													
19			P													
20			L													
21			H													
22			P													
23			P													
24			H													

NOTE: Logic probe readings taken after just turning computer on (power-up) unless otherwise noted. Unit with integer Basic in ROM and without Auto-start ROM used for logic probe readings.

NOTE: RFI Revision with computer in Monitor mode.

(6) Measured after pressing SPACE BAR on keyboard.

(7) Low in Graphics mode.

(12) Open.

Logic Probe display

L = Low
H = High
P = Pulse

LOGIC (MAIN) BOARD (Continued)

PIN NO.	IC UB7	IC UB8	IC UB9	IC UB10	IC UB11	IC UB12	IC UB13	IC UB14	IC UC1	IC UC2	IC UC3	IC UC4	IC UC5	IC UC6	IC UC7	IC UC8
1	P	H	H	H	H	P	P	P	L	H	L	L	L	L	L	L
2	L(6)	L	H	P	P	P	L	P	P	L	P	P	P	P	P	P
3	P	L	P	P	P	P	P	P	P	L	P	P	P	P	P	P
4	P	P	P	H	L	P	P	P	P	P	P	P	P	P	P	P
5	L	P	P	P	L	H	P	P	P	P	P	P	P	P	P	P
6	P	P	P	P	L	P	P	P	L	P	P	P	P	P	P	P
7	P	P	P	L	L	L	P	L	P	P	P	P	P	P	P	P
8	L	L	L	H	P	P	P	P	L	L	H	H	H	H	H	H
9	P	P	P	L	P	P	P	P	P	P	H	H	H	H	H	H
10	P	P	P	H	P	P	P	P	P	P	P	P	P	P	P	P
11	L(6)	P	P	L	P	P	P	P	P	P	P	P	P	P	P	P
12	P	P	P	H	P	P	H	P	P	P	P	P	P	P	P	P
13	P	P	P	H	P	P	L	P	P	P	P	P	P	P	P	P
14	H(6)	L	P	H	H	H	H	H	P	P	P	P	P	P	P	P
15	P	L	P	P	P	P	P	L	P	P	P	P	P	P	P	P
16	H	H	H	H	H	H	H	H	H	H	L	L	L	L	L	L

PIN NO.	IC UC9	IC UC10	IC UC11	IC UC12	IC UC13	IC UC14	IC UD2	IC UD3	IC UD4	IC UD5	IC UD6	IC UD7	IC UD8	IC UD9	IC UD10	IC UD11
1	L	L	L	L	P	(12)	P	L	L	L	L	L	L	L	L	H
2	P	P	H	H	P	(12)	P	P	P	P	P	P	P	P	P	P
3	P	P	H	P	P	H	P	P	P	P	P	P	P	P	P	P
4	P	P	L	H	P	P	P	P	P	P	P	P	P	P	P	P
5	P	P	P	L	P	P	P	P	P	P	P	P	P	P	P	P
6	P	P	P	P	P	P	P	P	P	P	P	P	P	P	P	P
7	P	P	L	L	L	L	L	P	P	P	P	P	P	P	P	P
8	H	H	P	L	P	P	P	H	H	H	H	H	H	H	H	H
9	H	H	P	L	P	P	H	H	H	H	H	H	H	H	H	P
10	P	P	P	H	P	P	P	P	P	P	P	P	P	P	P	P
11	P	P	P	L	P	P	H	P	P	P	P	P	P	P	P	P
12	P	P	L	P	P	P	P	P	P	P	P	P	P	P	P	P
13	P	P	H	P	P	P	P	P	P	P	P	P	P	P	P	P
14	P	P	H	P	H	H	H	P	P	P	P	P	P	P	P	P
15	P	P	H	P	H	H	H	H	H	H	H	H	H	H	H	H
16	L	L	H	H	H	H	H	L	L	L	L	L	L	L	L	H

APPLE MODELS II, II PLUS

NOTE: Logic probe readings taken after just turning computer on (power-up) unless otherwise noted. Unit with integer Basic in ROM and without Auto-start ROM used for logic probe readings.

NOTE: RFI Revision with computer in Monitor mode.

(6) Measured after pressing SPACE BAR on keyboard.

(12) Open.

Logic Probe display
 L = Low
 H = High
 P = Pulse

LOGIC (MAIN) BOARD (Continued)

PIN NO.	IC UD12	IC UD13	IC UD14	IC UE3	IC UE4	IC UE5	IC UE6	IC UE7	IC UE8	IC UE9	IC UE10	IC UE11	IC UE12	IC UE13	IC UE14	IC UF2
1	H	H	H	L	L	L	L	L	L	L	L	L	L	L	P	P
2	P	P	P	P	P	P	P	P	P	P	P	P	P	P	P	P
3	H	L	L	P	P	P	P	P	P	P	P	L	P	P	P	P
4	L	L	L	P	P	P	P	P	P	P	P	P	P	P	P	P
5	P	H	L	P	P	P	P	P	P	P	P	P	P	P	P	H
6	H	P	L	P	P	P	P	P	P	P	P	H	P	P	H	H
7	P	P	H	P	P	P	P	P	P	P	P	P	P	P	P	P
8	L	L	L	H	H	H	H	H	H	H	H	L	L	L	L	L
9	P	P	P	H	H	H	H	H	H	H	H	P	P	P	P	P
10	P	P	H	P	P	P	P	P	P	P	P	L	P	P	P	P
11	P	P	P	P	P	P	P	P	P	P	P	L	P	P	P	H
12	P	P	P	P	P	P	P	P	P	P	P	P	P	P	P	H
13	P	P	P	P	P	P	P	P	P	P	P	P	P	P	P	P
14	P	P	P	P	P	P	P	P	P	P	P	P	P	P	P	P
15	P	P	P	H	H	H	H	H	H	H	H	L	L	L	L	L
16	H	H	H	L	L	L	L	L	L	L	L	H	H	H	H	H

PIN NO.	IC UF3	IC UF5	IC UF6	IC UF8	IC UF9	IC UF11	IC UF12	IC UF13	IC UF14	IC UH1	IC UH2	IC UH3	IC UH4	IC UH5		
1	L	L	L	L	L(13)	L	P	P	P	(12)	P	L	L	L		
2	P	P	P	P	P(13)	P	P	P	P	(12)	P	L	L	P		
3	P	P	P	P	P(13)	P	P	P	P	H	P	L	P	P		
4	P	P	P	P	P(13)	P	P	L(8,9)	H	P	P	P	P	P		
5	P	P	P	P	P(13)	P	P	P	H	P	P	P	P	P		
6	P	P	P	P	P(13)	P	P	P	L	P	L	L	P	P		
7	P	P	P	P	P(13)	P	P	H	L	L	L	L	P	P		
8	P	P	P	P	P(13)	P	L	L	L	L	L	L	L	L		
9	P	P	P	P	P(13)	P	H	H(8)	L(14)	L	H	P	P	P		
10	P	P	P	P	P(13)	P	H	H	H	L	H	P	P	P		
11	P	P	P	P	P(13)	P	H	H	H	H	H	P	P	P		
12	L	L	L	L	L(13)	L	H	H(10)	H	(12)	H	P	P	P		
13	P	P	P	P	P(13)	P	H	H(9)	P	(12)	H	H	P	P		
14	P	P	P	P	P(13)	P	H	H	H	H	H	(12)	P	P		
15	P	P	P	P	P(13)	P	P	P(11)	H	H	H	L	L	L		
16	P	P	P	P	P(13)	P	H	H	H	H	H	H	H	H		
17	P	P	P	P	P(13)	P										
18	H	H	H	H	H(13)	H										
19	P	P	P	P	P(13)	P										
20	P	H	H	H	H(13)	H										
21	P	H	H	H	H(13)	H										
22	L	L	L	L	L(13)	L										
23	P	P	P	P	P(13)	P										
24	H	H	H	H	H(13)	H										

NOTE: Logic probe readings taken after just turning computer on (power-up) unless otherwise noted. Unit with integer Basic in ROM and without Auto-start ROM used for logic probe readings.

NOTE: RFI Revision with computer in Monitor mode.

- (8) Probe will show P while Loading a program from tape.
- (9) Probe will show P while Saving a program on tape.
- (10) Probe will show P while beeping the on-board speaker.

- (11) Probe will show H while Loading a program from tape.
- (12) Open.
- (13) Used only with Apple II plus.
- (14) With Auto-start ROM.

Logic Probe display
 L = Low
 H = High
 P = Pulse

PIN NO.	IC UH7	IC UH10	IC UH12	IC UH13	IC UH14	IC WJ1	IC WJ3	IC UB2	IC UB3	IC UB4	IC UB5	IC UB6
1	L	P	P	(12)	(12)	P	H	L	H	H(6)	L(6)	P
2	H	P	L	(12)	(12)	(12)	H(10)	P(15)	H	H(6)	H(6)	P
3	P	P	P	H	(12)	(12)	H(10)	P(15)	L	L(6)	H(6)	P
4	H	P	P	H	H(8)	H	H	H(15)	L	(12)	L(6)	H(15)
5	(12)	P	P	H	P	(12)	L(10)	H(15)	L	(12)	H(6)	H
6	H	P	H	H	(8,12)	(12)	H(10)	L	H	L	L(6)	H
7	P	P	H	(12)	H(8)	H	L	P(15)	L	L	L	H
8	H	P	L	(12)	L	L	H(9)	H	L	H	L(6)	H(6)
9	P	L	H	(12)	P	P	L(9)		H	L	H(6)	L(6)
10	P	L	H	(12)	P	P	H		H	L	L(6)	H(6)
11	P	P	H	H	P	L	H(9)		L	L	H(6)	H(6)
12	P	P	H	L	(12)	P	H(9)		H	H	L(6)	H(6)
13	P	P	H	H	(12)	P	H		H	H	H(6)	H(6)
14	P	P	H	H	(12)	L	H		H	H	H	H(6)
15	P	P	P	(12)	(12)	L						L
16	L	P	H	(12)	H	H						L(2,5)
17	P	P										P
18	L	P										P
19	P	P										P
20	P	H										P
21	L											P
22	P											P
23	P											P
24	P											P
25	P											P
26	P											P
27	P											L
28	P											L(4)
29	P											L(3)
30	P											H
31	P											L
32	P											P
33	P											P
34	P											P
35	(12)											P
36	(12)											P
37	P											P
38	L											P
39	P											P
40	H											P

APPLE
MODELS II, II PLUS

NOTE: Logic probe readings taken after just turning computer on (power-up) unless otherwise noted. Unit with integer Basic in ROM and without Auto-start ROM used for logic probe readings.

NOTE: RFI Revision with computer in Monitor mode.

- (1) Reading goes high when a key is pressed.
- (2) SHIFT, CTRL, REPT and RESET keys have no effect.
- (3) Reading goes high when SHIFT key is pressed.
- (4) Reading goes high when CTRL key is pressed.
- (5) Probe will show a pulse when a key is pressed.
- (6) Measured after pressing SPACE BAR on keyboard.

- (7) Low in Graphics mode.
- (8) Probe will show P while Loading a program from tape.
- (9) Probe will show P while Saving a program on tape.
- (10) Probe will show P while beeping the on-board speaker.
- (11) Probe will show H while Loading a program from tape.
- (12) Open.
- (13) Used only with Apple II plus.
- (14) With Auto-start ROM.
- (15) Readings taken with P and REPT keys depressed.

Logic Probe display
L = Low
H = High
P = Pulse

DISASSEMBLY INSTRUCTIONS

CABINET LID REMOVAL

Turn the computer so that the back is facing you. Place your fingers on the top of the lid and your thumbs under the lid's outside edges and press upward with thumbs until the lid releases from the cabinet. Sometimes this requires a lot of pressure before it releases. When the lid comes loose, lift it up and back. See Figure 6.

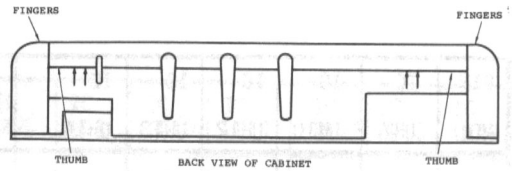

Figure 6

CABINET TOP REMOVAL

The keyboard and keyboard encoder are part of the cabinet top. To remove cabinet top, remove 10 Phillips screws from the cabinet bottom, four Phillips screws from the rear of the computer mother board (RFI version only). Lift the cabinet top up and back to slide the rear shield (RFI version only) from under the main board. Disconnect the 16-pin ribbon cable from the computer mother board. Make sure to mark the 16-pin plug for proper placement in the mother board. Replace the four Phillips screws along with the spacer bar at the rear of the mother board. Store the cabinet screws in the original threaded holes. See Figure 7.

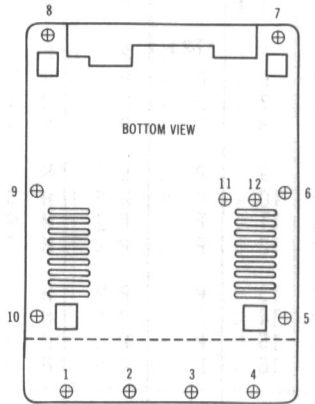

Figure 7

KEYBOARD AND ENCODER BOARD REMOVAL

See "Cabinet Top Removal" and remove cabinet top. To remove keyboard and encoder board, remove screws 1 thru 4. The keyboard and encoder board can now be removed from the cabinet top. See Figure 8.

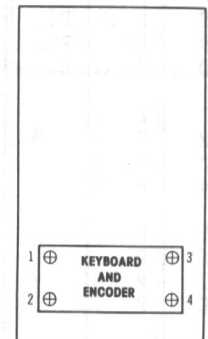
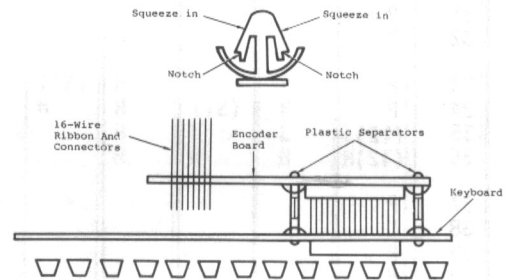

Figure 8

SEPARATE ENCODER FROM KEYBOARD

To separate the keyboard from the encoder board, squeeze the top of the plastic separators and ease the board past the notches. Both plastic separators must be squeezed to allow for board removal. See Figure 9.



Figure

POWER SUPPLY REMOVAL

The power supply can be removed by removing four screws (11 thru 14, Figure 10) from the bottom. Unplug the power supply plug from the mother board and remove the power supply.

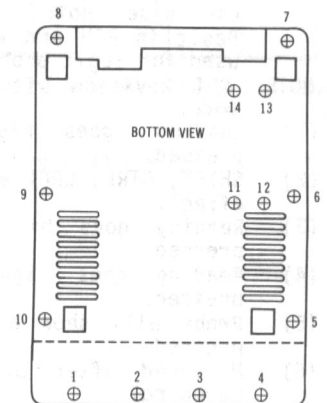

Figure 10

DISASSEMBLY INSTRUCTIONS (Continued)

POWER SUPPLY CASE BOTTOM REMOVAL

Remove 10 Phillips screws from the sides of the power supply case bottom. Use a small blade screw-driver to pry the case bottom from the sides and top of the power supply case.

NOTE: Older units may use eight screws and two pop-rivet washers to hold the bottom. Use needle-nose pliers to hold the washers and drill the pop-rivet washers in the center, use 5/32" drill bit. Replace the pop-rivet washers after servicing the power supply. See Figure 11.

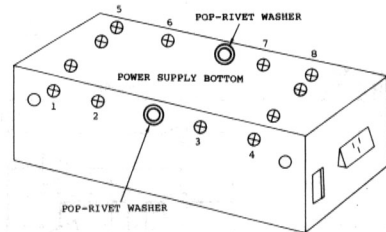

Figure 11.

POWER SUPPLY BOARD REMOVAL

See the "Power Supply Case Bottom Removal" and remove bottom. Unplug the wires going to plugs N and L. Squeeze and remove the DC power cord grommet from the chassis. Remove six Phillips screws from the board and lift the board from the case. See Figures 12 and 13.

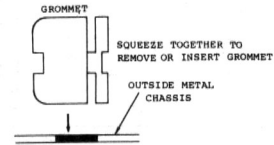

Figure 12

MOTHER BOARD REMOVAL FROM BOTTOM OF CHASSIS

RFI VERSION

Remove the power plug from the mother board (squeeze the front and back of the plug and lift up). Remove speaker plug from back (pull up). Remove four Phillips screws (1 thru 4, Figure 14) from the back of the board. Pinch in the plastic retainer tab on the five board standoffs (5 thru 9, Figure 14) to see-saw the board past each retainer tab notch. Carefully see-saw the board up the standoffs until it is free. **CAUTION:** Use small steps to avoid damaging the board.

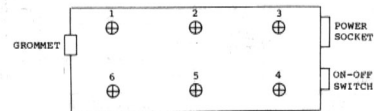

Figure 13

OLDER VERSIONS

Remove the power plug from the mother board (squeeze the front and back of the plug and lift up). Remove speaker plug from jack (pull up). Remove 1/4" nut and star washer. Make sure insulation washer on bottom of 1/4" stud is retained for reinstallation. Pinch in the plastic retainer tab on all six of the board standoffs to see-saw the board past each retainer tab notch. Carefully see-saw the board up the standoffs until it is free. **CAUTION:** Use small steps to avoid damaging the board. See Figure 15.

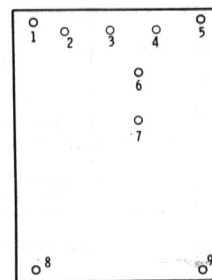

Figure 14

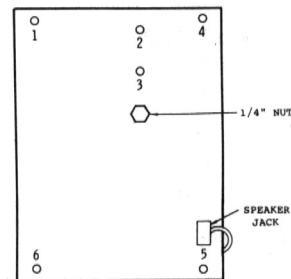
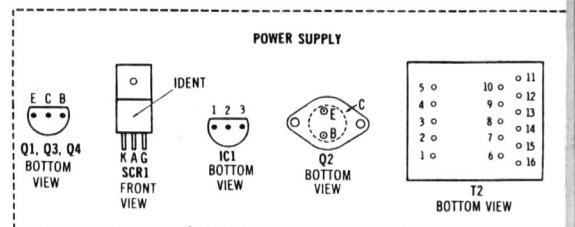
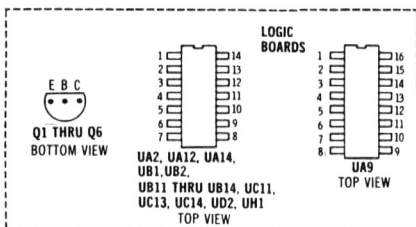
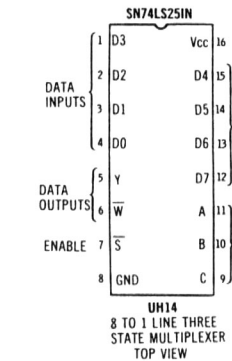
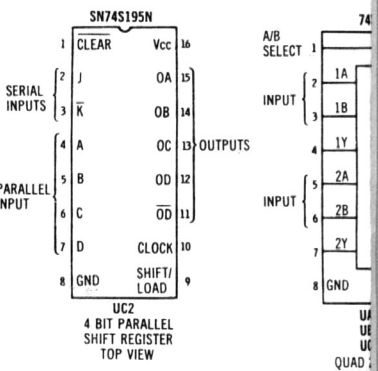
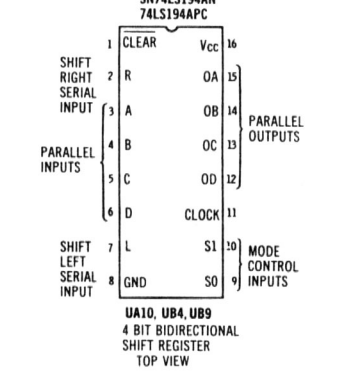
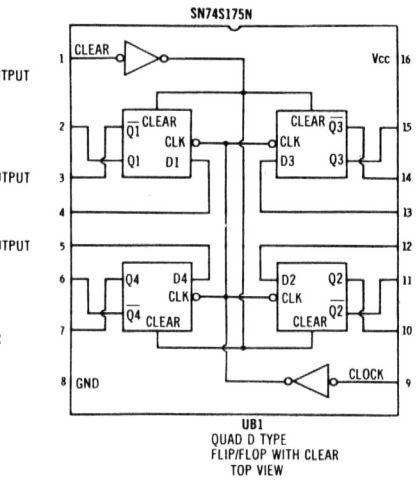
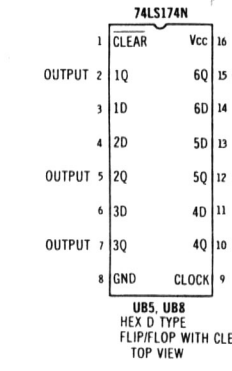
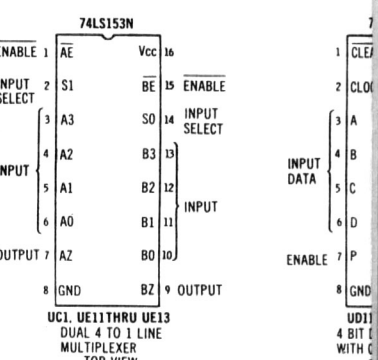
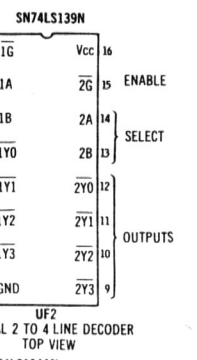
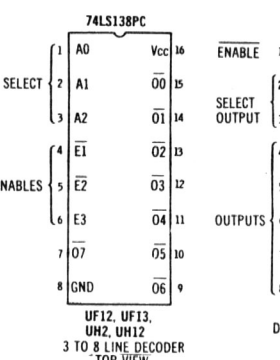
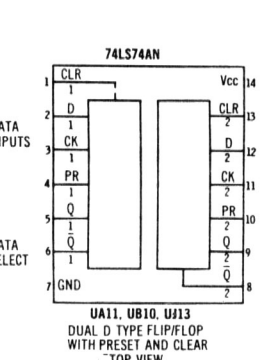
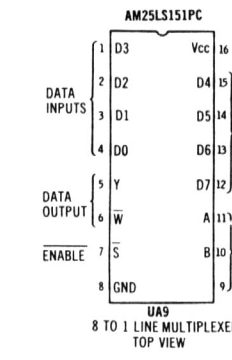
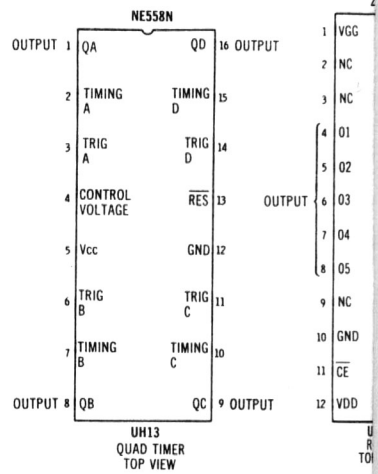
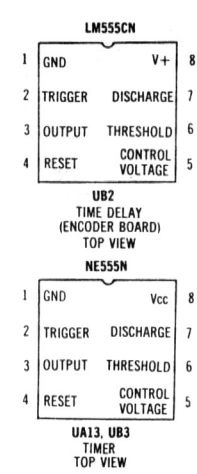
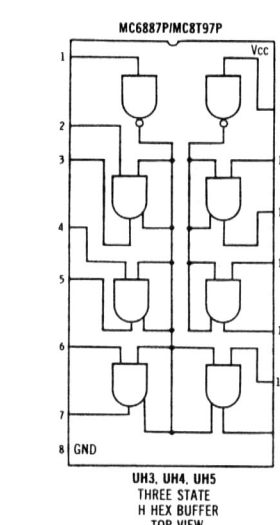
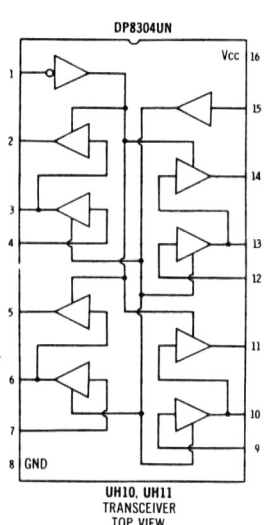
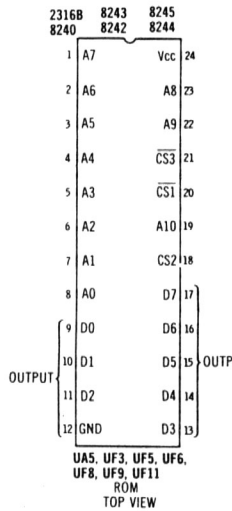

Figure 15



IC PINOUT DEFINITIONS

A.....Address
AKO.....Address Keyboard Output
CE.....Chip Enable
CS.....Chip Select
CAS.....Column Address Strobe
D.....Data
E.....Enable
IRQ.....Interrupt Request
NMI.....Non-Maskable Interrupt

RAS.....Row Address Strobe
RDY.....Ready
R/W.....Read Write
WR.....Write
X.....X Coordinate
Y.....Y Coordinate
Ø0.....Phase Zero
Ø1.....Phase One

SAFETY PRECAUTIONS

1. Use an isolation transformer for servicing.
2. Maintain AC line voltage at rated input.
3. Remove AC power from the computer before servicing or installing electrostatically sensitive devices. Examples of typical ES devices are integrated circuits and semiconductor "chip" components.
4. Use extreme caution when handling the printed circuit boards. Some semiconductor devices can be damaged easily by static electricity. Drain off any electrostatic charge on your body by touching a known earth ground. Wear a commercially available discharging wrist strap device. This should be removed prior to applying power to the unit under test.
5. Use a grounded-tip, low voltage soldering iron.
6. Use an isolation (times 10) probe on scope.
7. Do not remove or install boards, floppy disk drives, printers, or other peripherals with computer AC power On.
8. Do not use freon-propelled sprays. These can generate electrical charges sufficient to damage semiconductor devices.
9. This computer is equipped with a grounded three-pronged AC plug. This plug must fit into a grounded AC power outlet. Do not defeat the AC plug safety feature.
10. Periodically examine the AC power cord for damaged or cracked insulation.
11. The computer cabinet is equipped with vents to prevent heat build-up. Never block, cover, or obstruct these vents.
12. Instructions should be given, especially to children, that objects should not be dropped or pushed into the vents of the cabinet. This could cause shock or equipment damage.
13. Never expose the computer to water. If exposed to water turn the unit off. Do not place the computer near possible water sources.
14. Never leave the computer unattended or plugged into the AC outlet for long periods of time. Remove AC plug from AC outlet during lightning storms.
15. Do not allow anything to rest on AC power cord.
16. Unplug AC power cord from outlet before cleaning computer.
17. Never use liquids or aerosols directly on the computer. Spray on cloth and then apply to the computer cabinet. Make sure the computer is disconnected from the AC power line.

APPLE
MODELS II, II PLUS

LOGIC (MAIN) BOARD

A Howard W. Sams CIRCUITRACE Photo

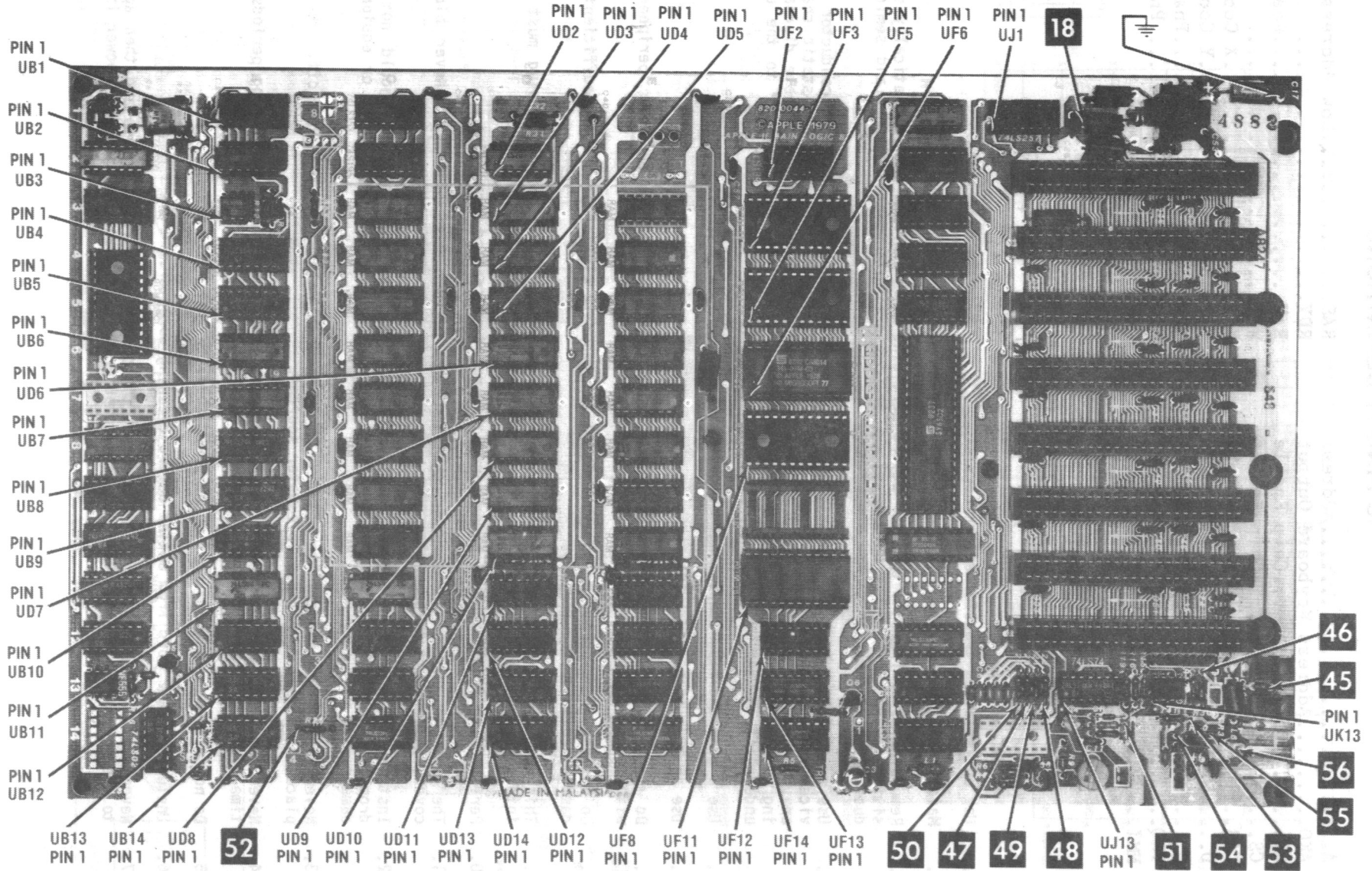

Trace LOCATION GUIDE

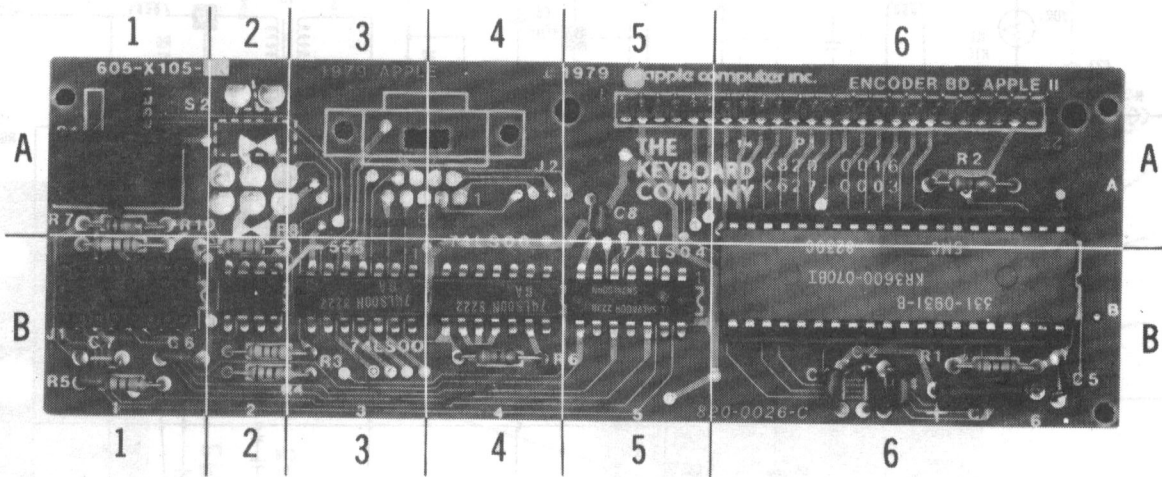

A Howard W. Sams GRIDTRACE™ Photo

APPLE
MODELS II, II PLUS

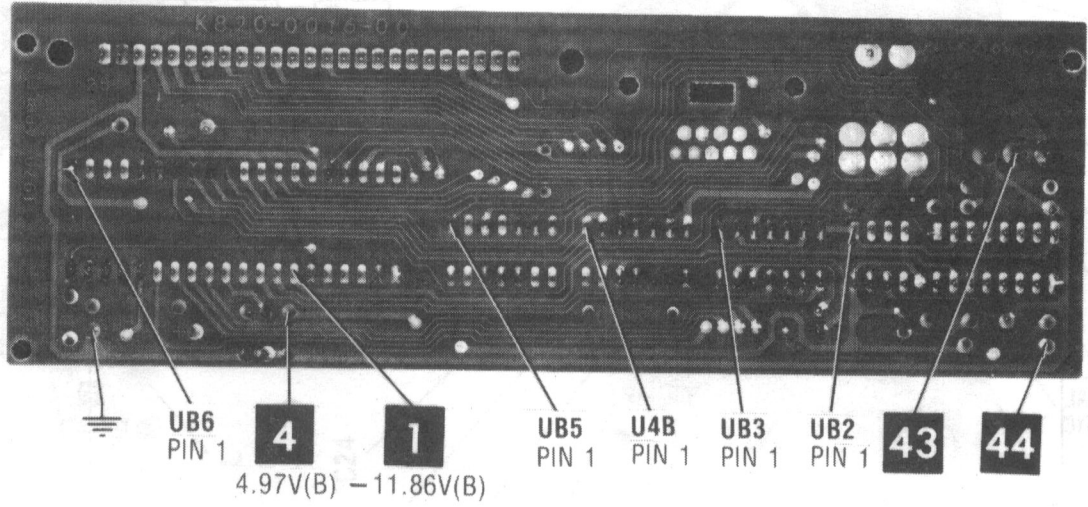

A Howard W. Sams CIRCUITRACE® Photo

ENCODER BOARD

POWER SUPPLY

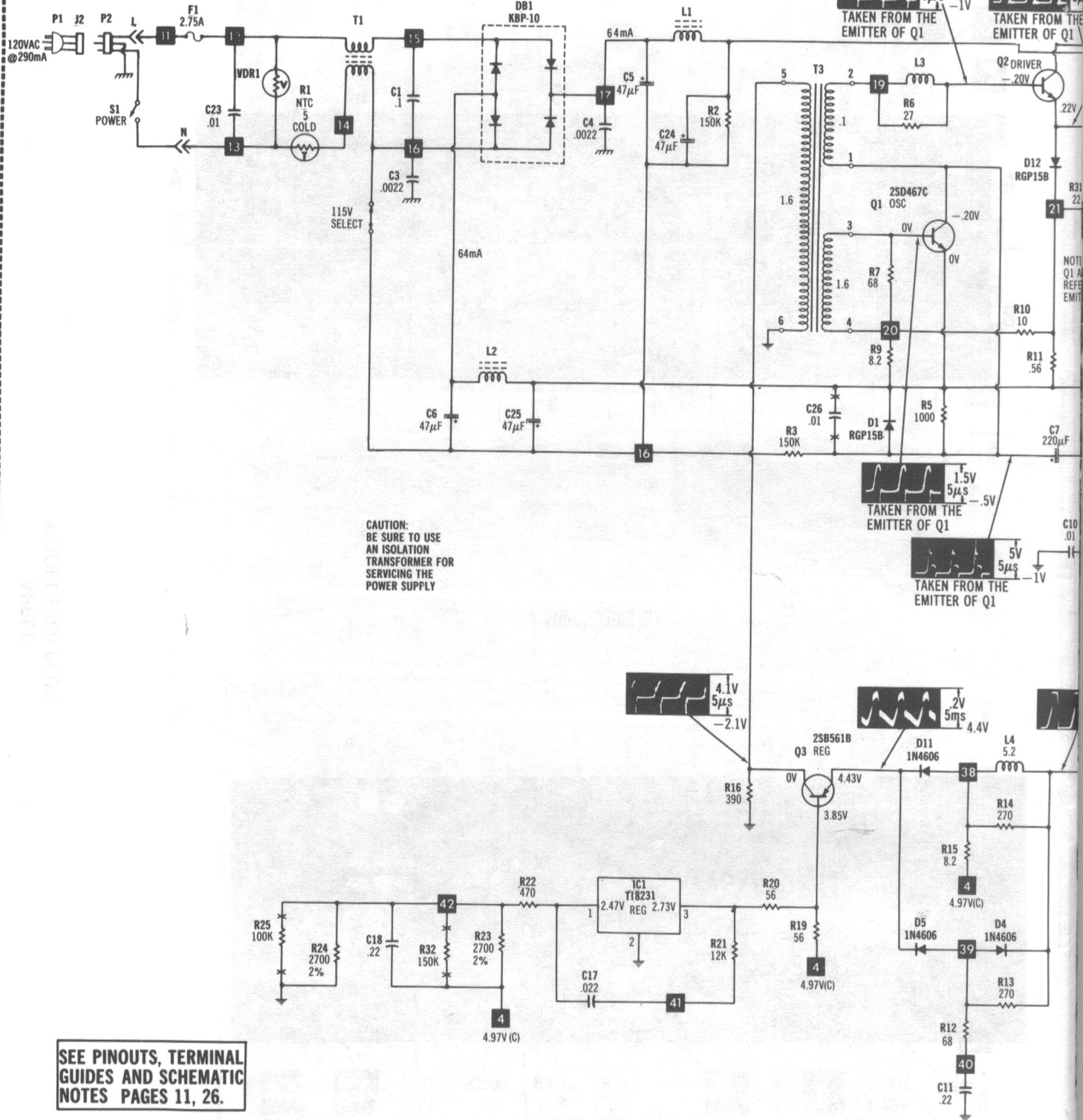

CAUTION:
BE SURE TO USE
AN ISOLATION
TRANSFORMER FOR
SERVICING THE
POWER SUPPLY

SEE PINOUTS, TERMINAL
GUIDES AND SCHEMATIC
NOTES PAGES 11, 26.

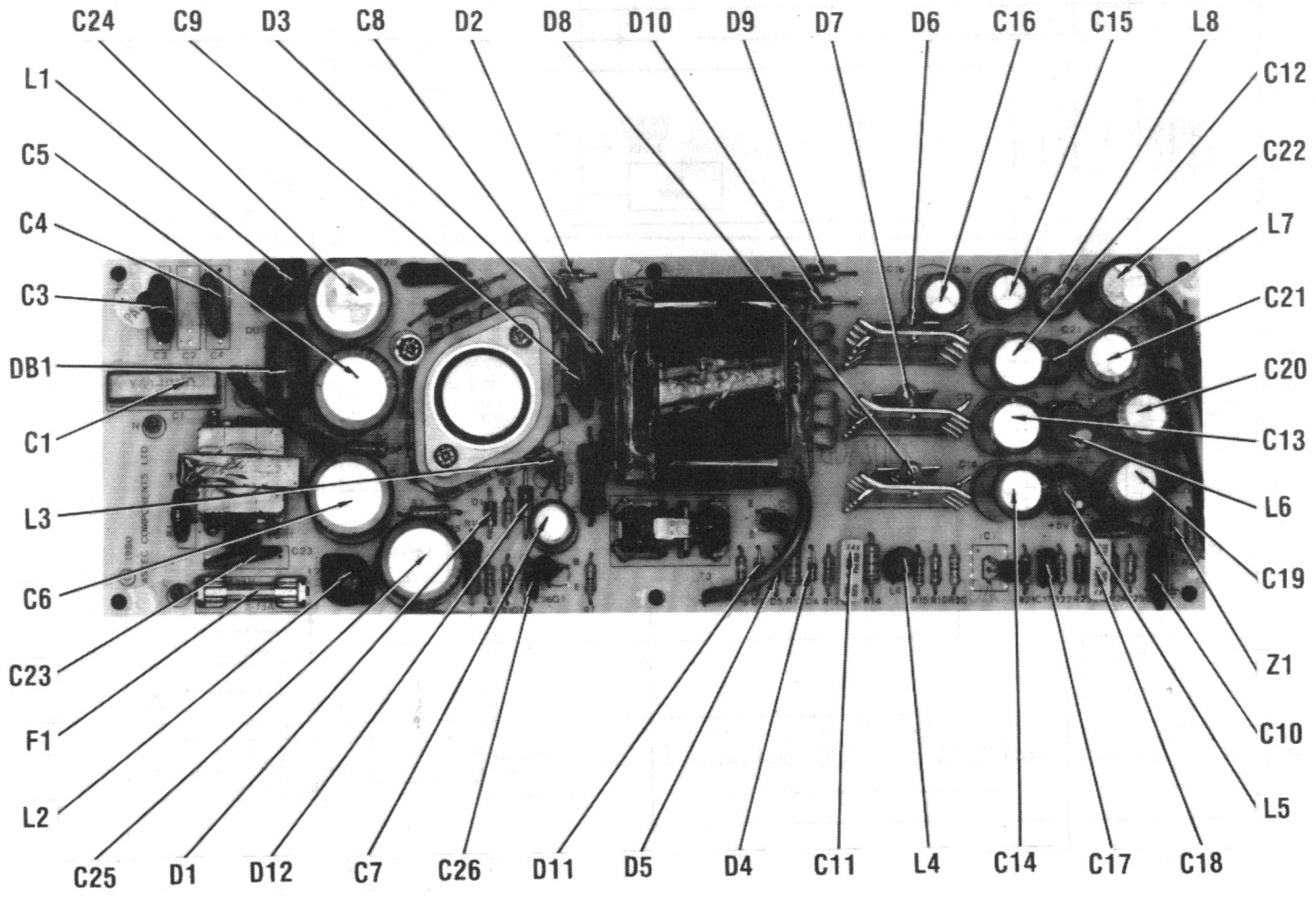
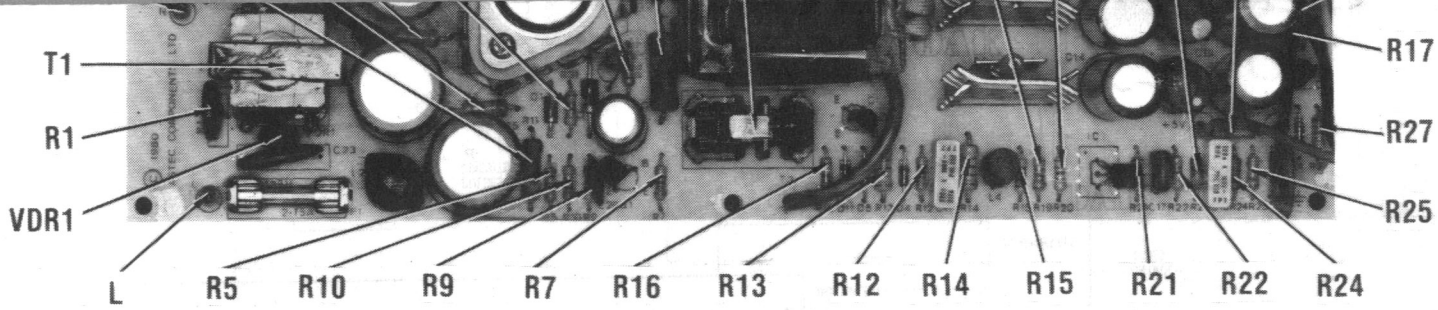

APPLE
MODELS II, II PLUS

POWER SUPPLY BOARD

BLOCK DIAGRAM

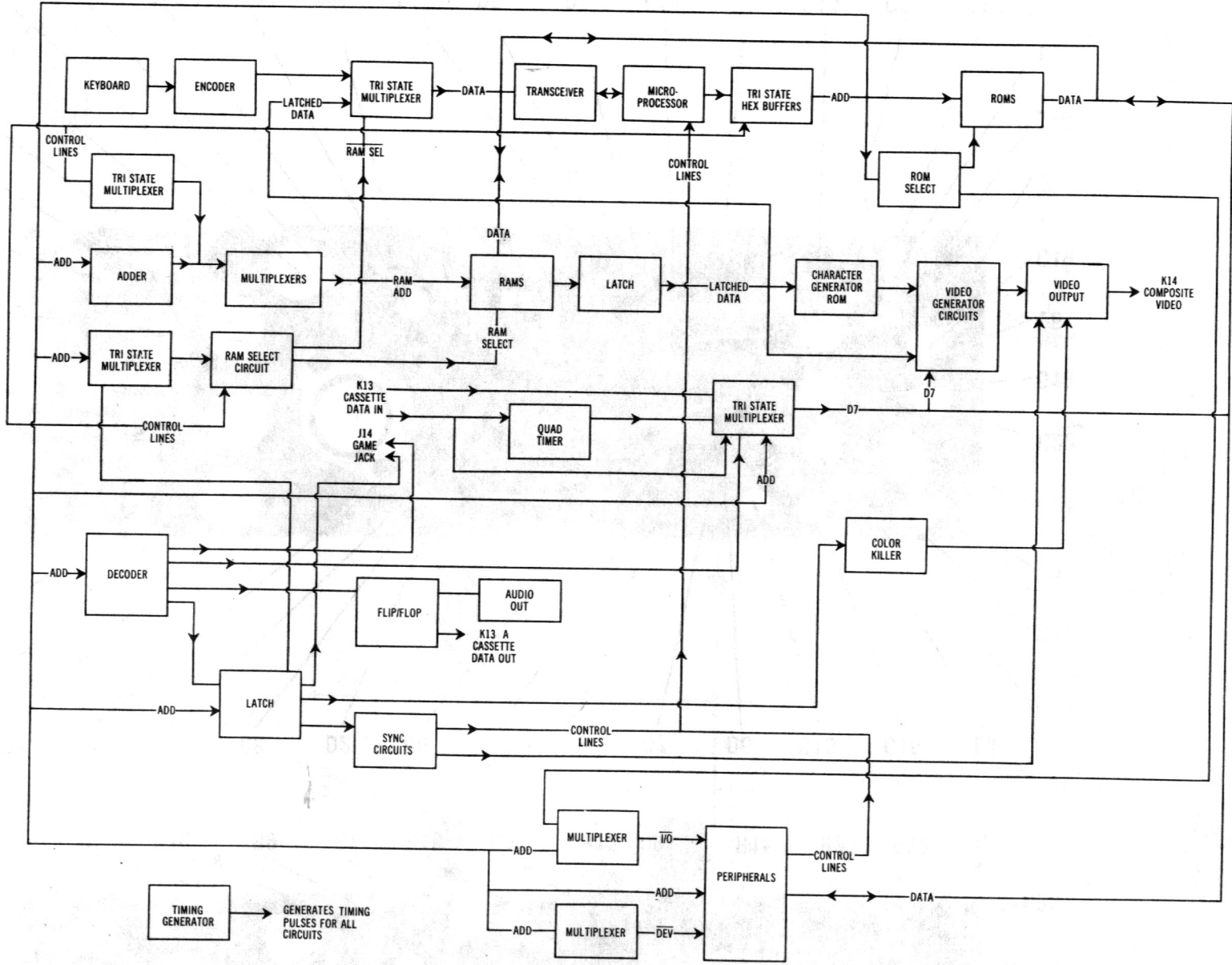

NUMERIC PAD

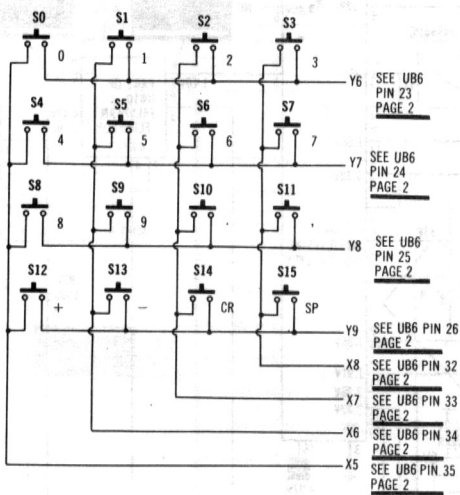

ALT VIDEO CIRCUIT 2

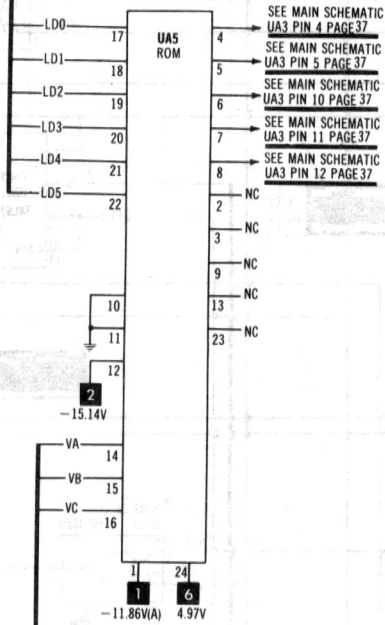

PART OF U1

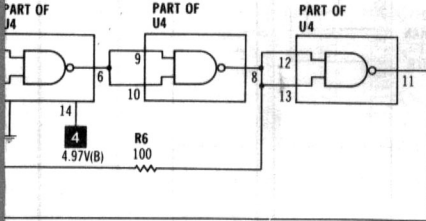
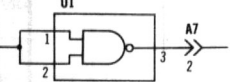

ALT VIDEO CIRCUIT 1

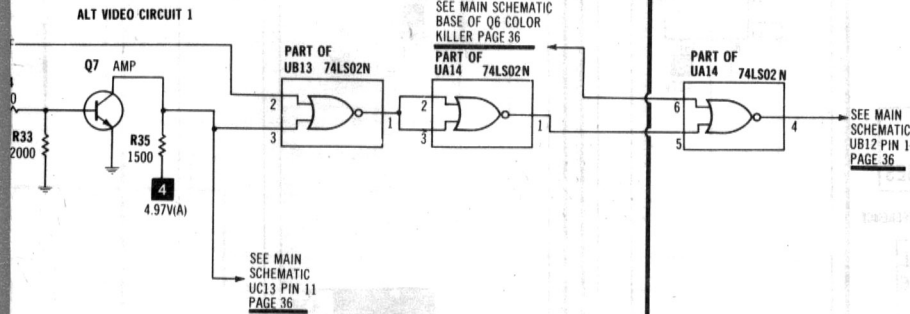

LINE IDENTIFICATIONS ASSIGNED FOR REFERENCE

**CABLING:
HEAVY LINE REDUCES
USE OF MULTIPLE LINES**

SEE LINE DEFINITIONS ON PAGE 14.

ALTERNATE KEYBOARD w/ENCODER & NUMERIC KEY PAD

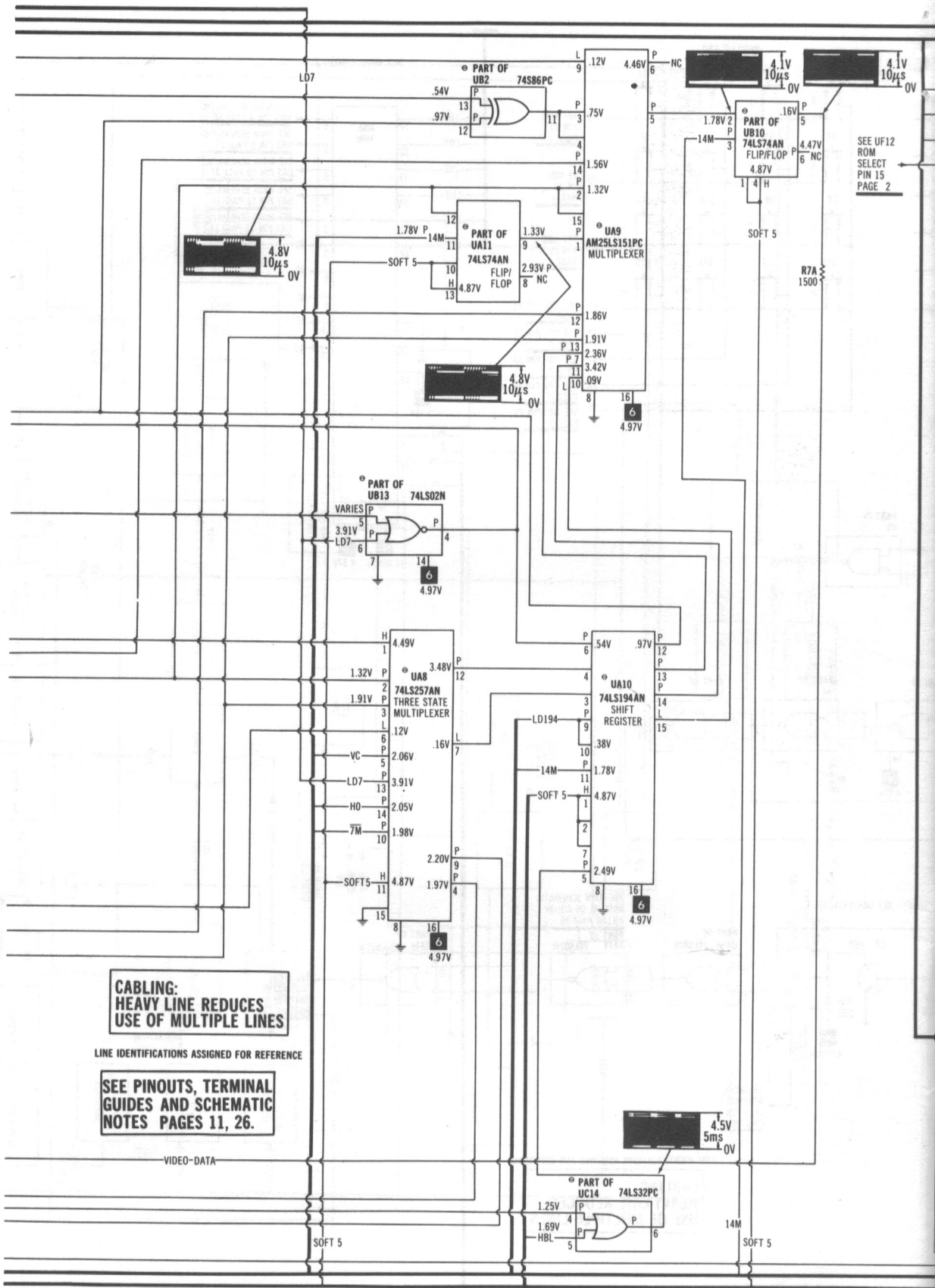

**CABLING:
HEAVY LINE REDUCES
USE OF MULTIPLE LINES**

LINE IDENTIFICATIONS ASSIGNED FOR REFERENCE

**SEE PINOUTS, TERMINAL
GUIDES AND SCHEMATIC
NOTES PAGES 11, 26.**

VIDEO-DATA

SOFT 5

SOFT 5

UF9 MAY 1

UF6 8242 ROM

4.49V 20H 21

UF12 74LS138P ROM SELECT

3.48V

2.02V 4.4

4.2

8 16 4.1

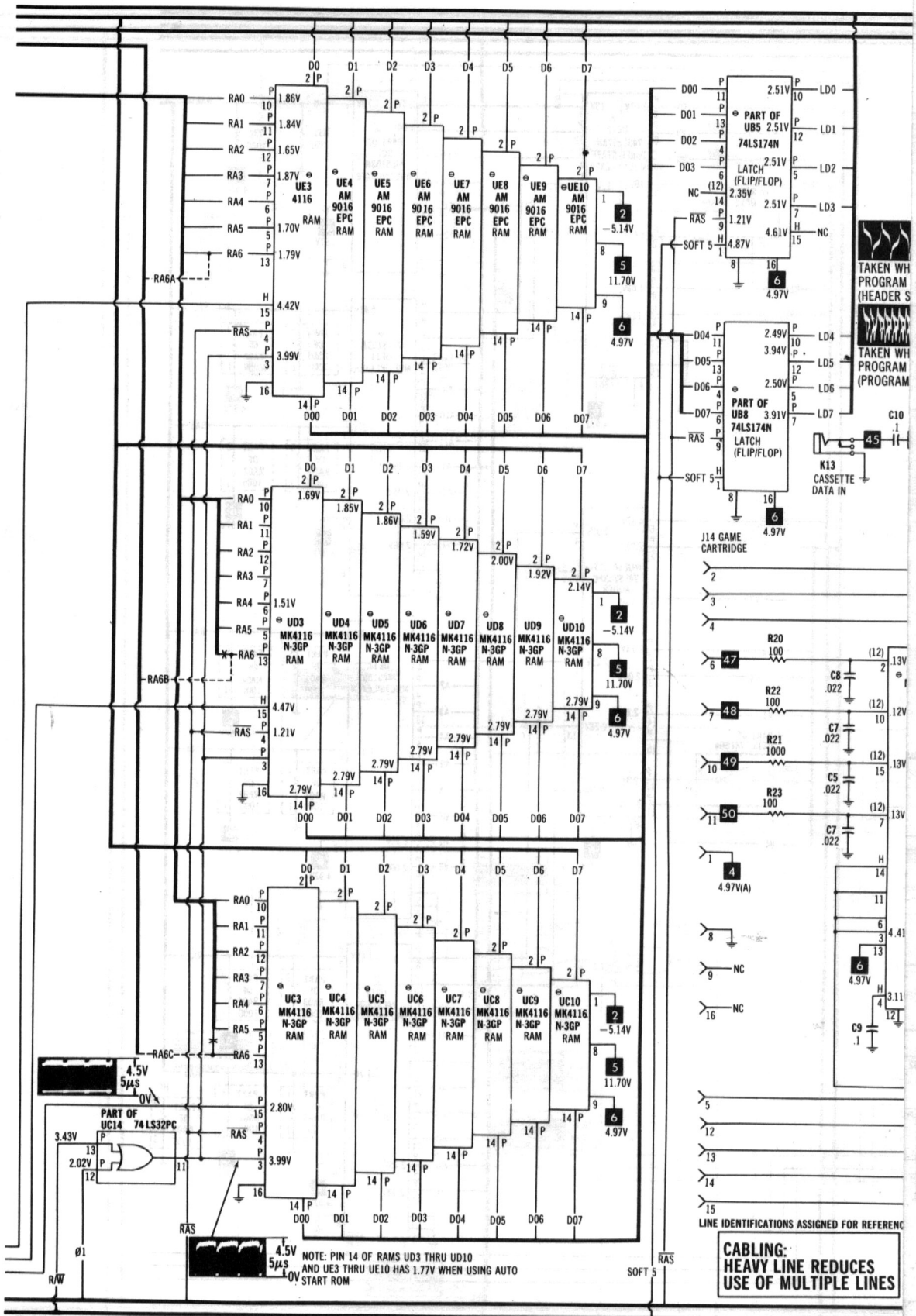

A PHOTOFAC STANDARD NOTATION SCHEMATIC WITH CIRCUITRACE

© Howard W. Sams & Co., Inc. 1984

LOGIC (MAIN) BOARD

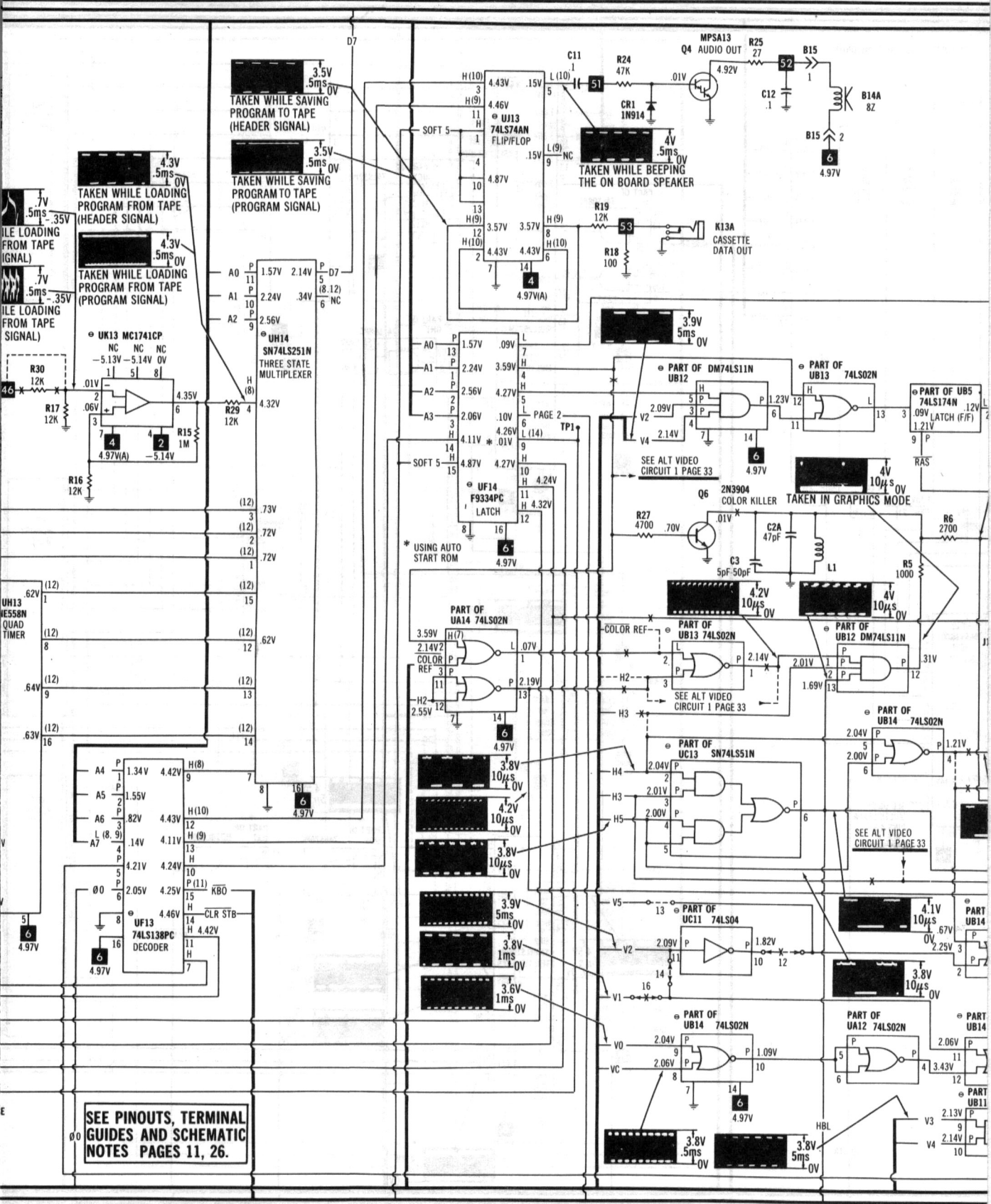

SEE LINE DEFINITIONS ON PAGE 14.

SEE ALTERNATE KEYBOARD
AND NUMERIC PAD PAGE 4

PART OF ENCODER BOARD

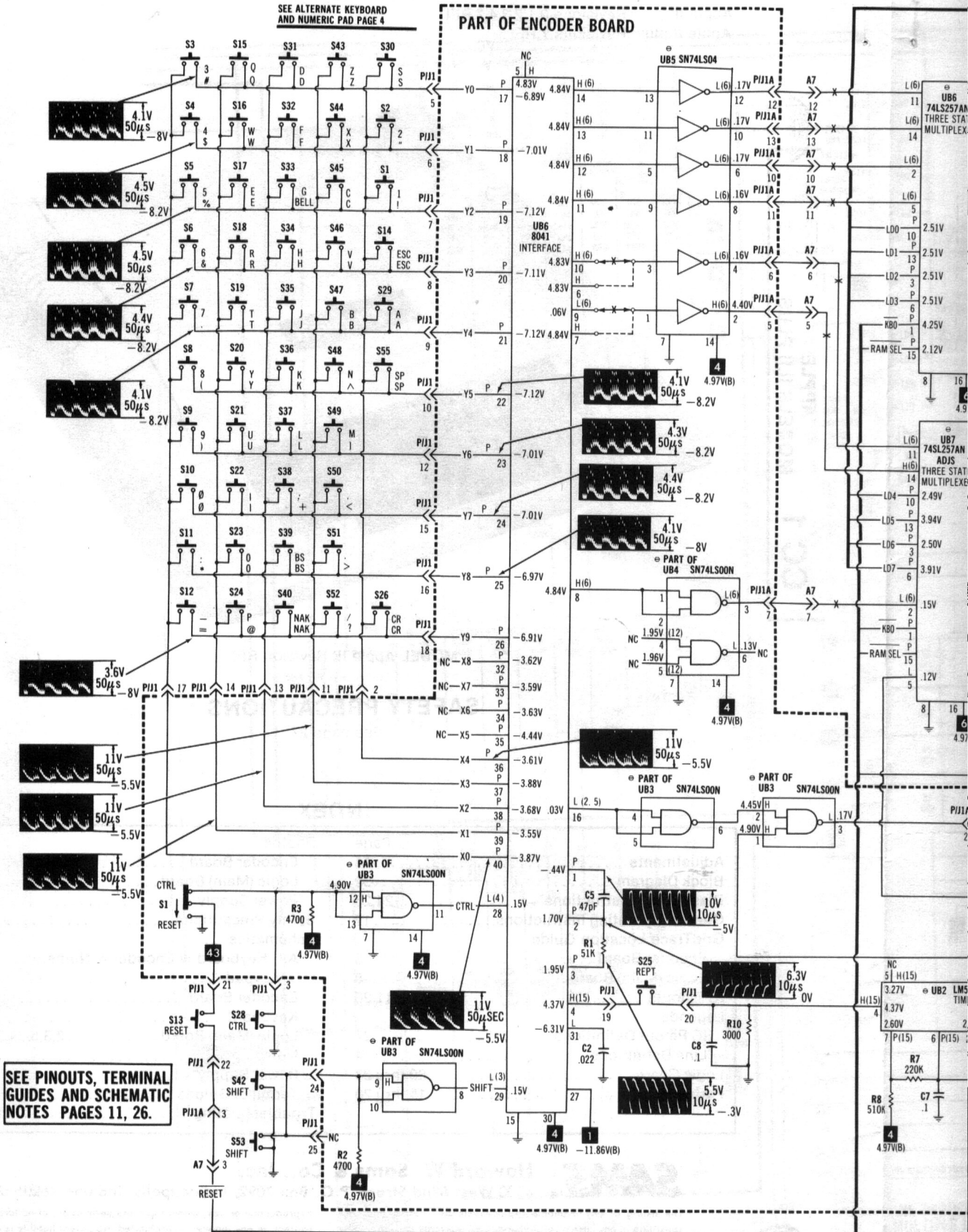

SEE PINOUTS, TERMINAL
GUIDES AND SCHEMATIC
NOTES PAGES 11, 26.

A PHOTOFAC STANDARD NOTATION SCHEMATIC
WITH **CIRCUITRACE**

© Howard W. Sams & Co., Inc. 1984

KEYBOARD, ENCODER & LOGIC (MAIN) BOARDS

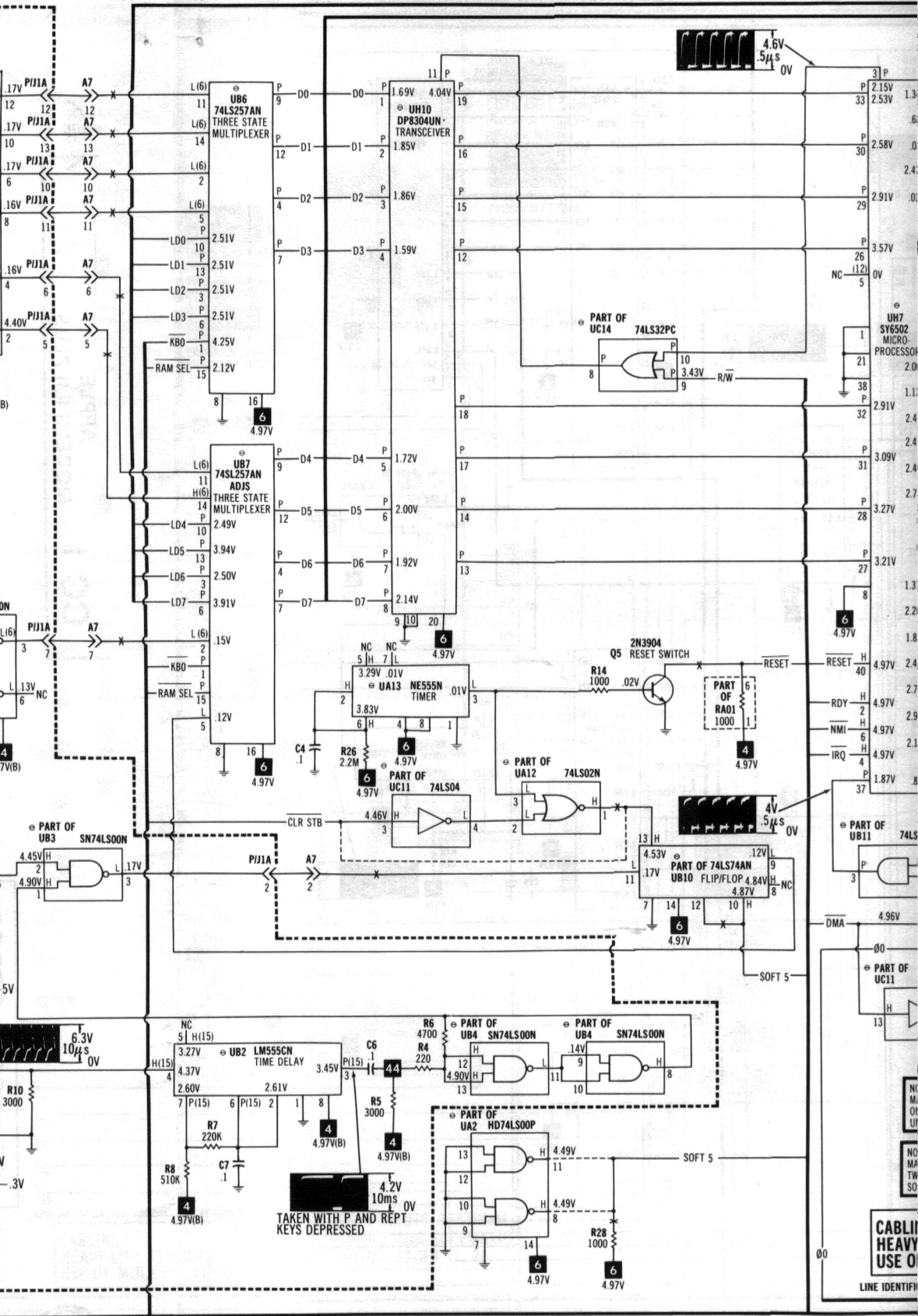

CABLE
HEAVY
USE OF
LINE IDENTIFI

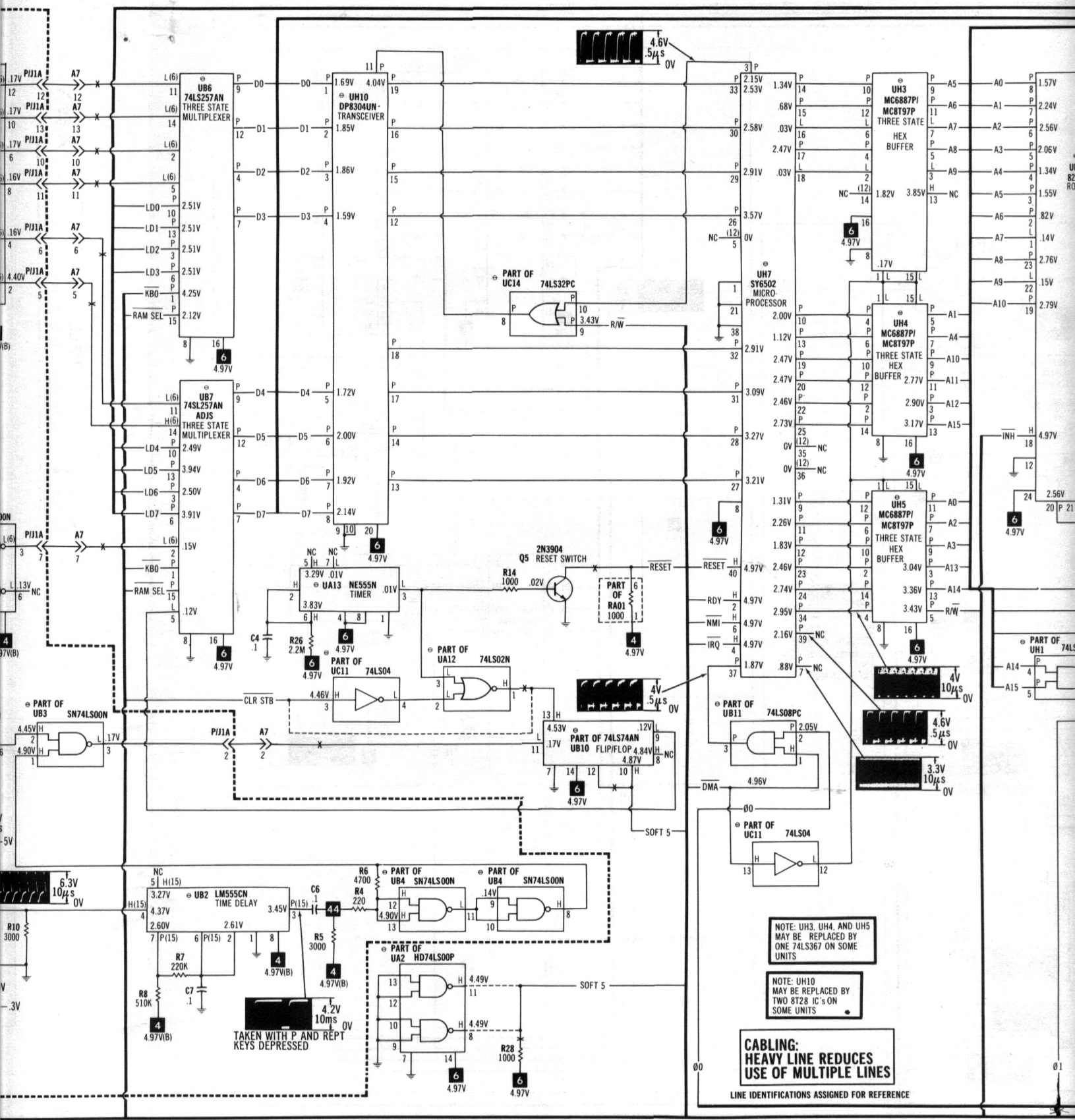

NOTE: UH3, UH4, AND UH5
MAY BE REPLACED BY
ONE 74LS367 ON SOME
UNITS

NOTE: UH10
MAY BE REPLACED BY
TWO 8T28 IC'S ON
SOME UNITS

**CABLING:
HEAVY LINE REDUCES
USE OF MULTIPLE LINES**

LINE IDENTIFICATIONS ASSIGNED FOR REFERENCE

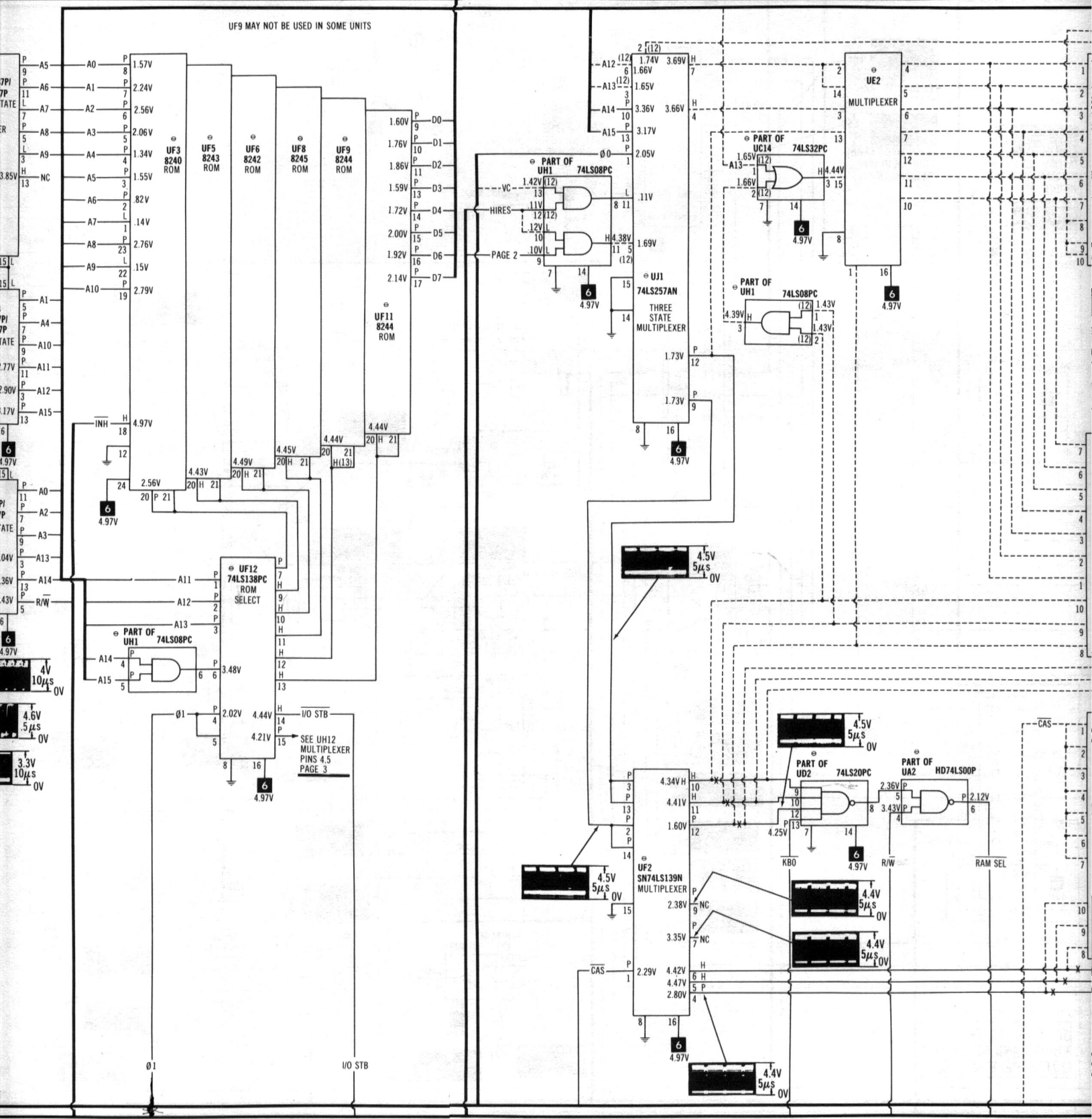

SEE LINE DEFINITIONS ON PAGE 14.

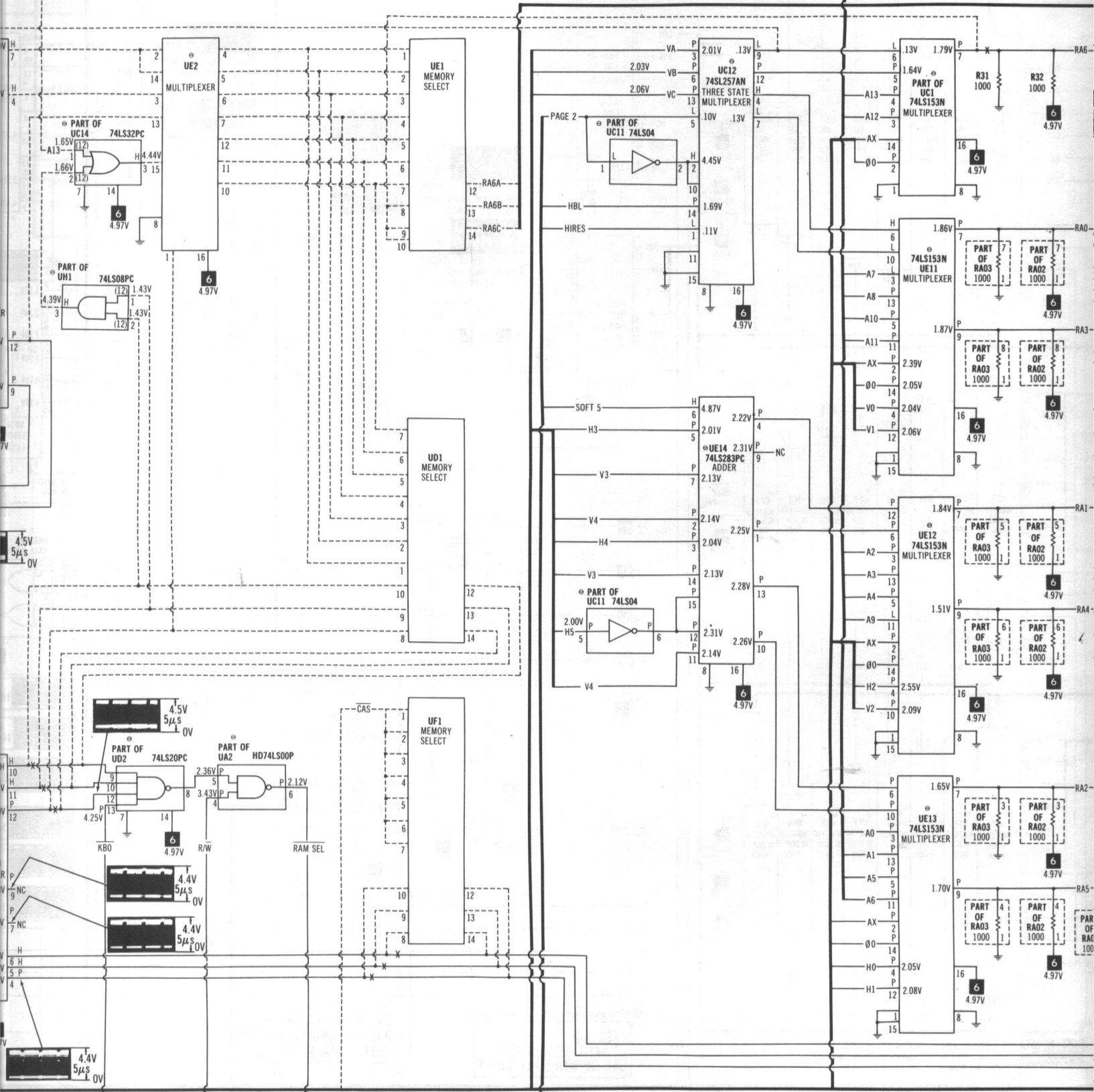

KEYBOARD, ENCODER & LOGIC (MAIN) BOARD

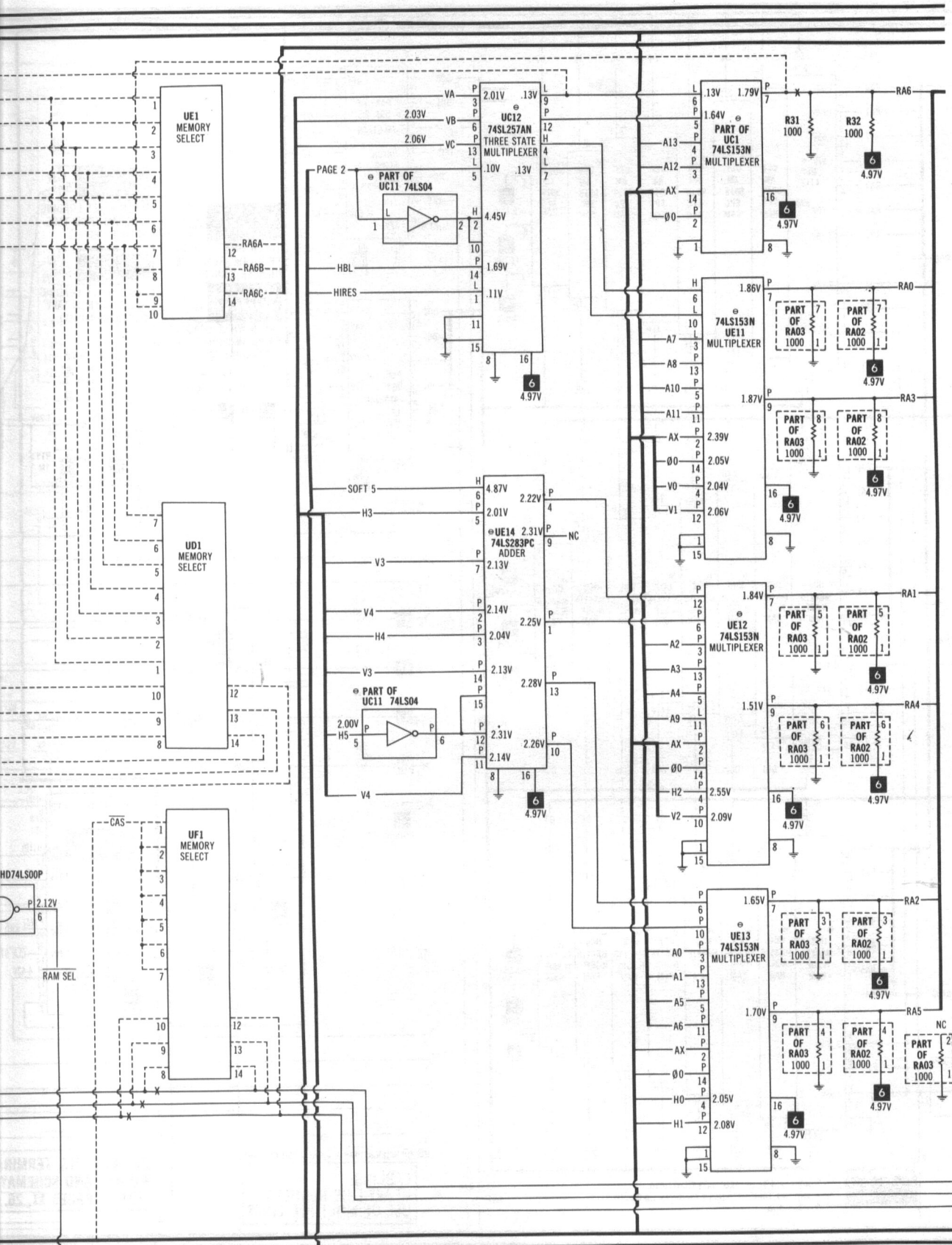

APPLE
KEYBOARD, ENCODER & LOGIC (MAIN) BOARDS MODELS II, II PLUS

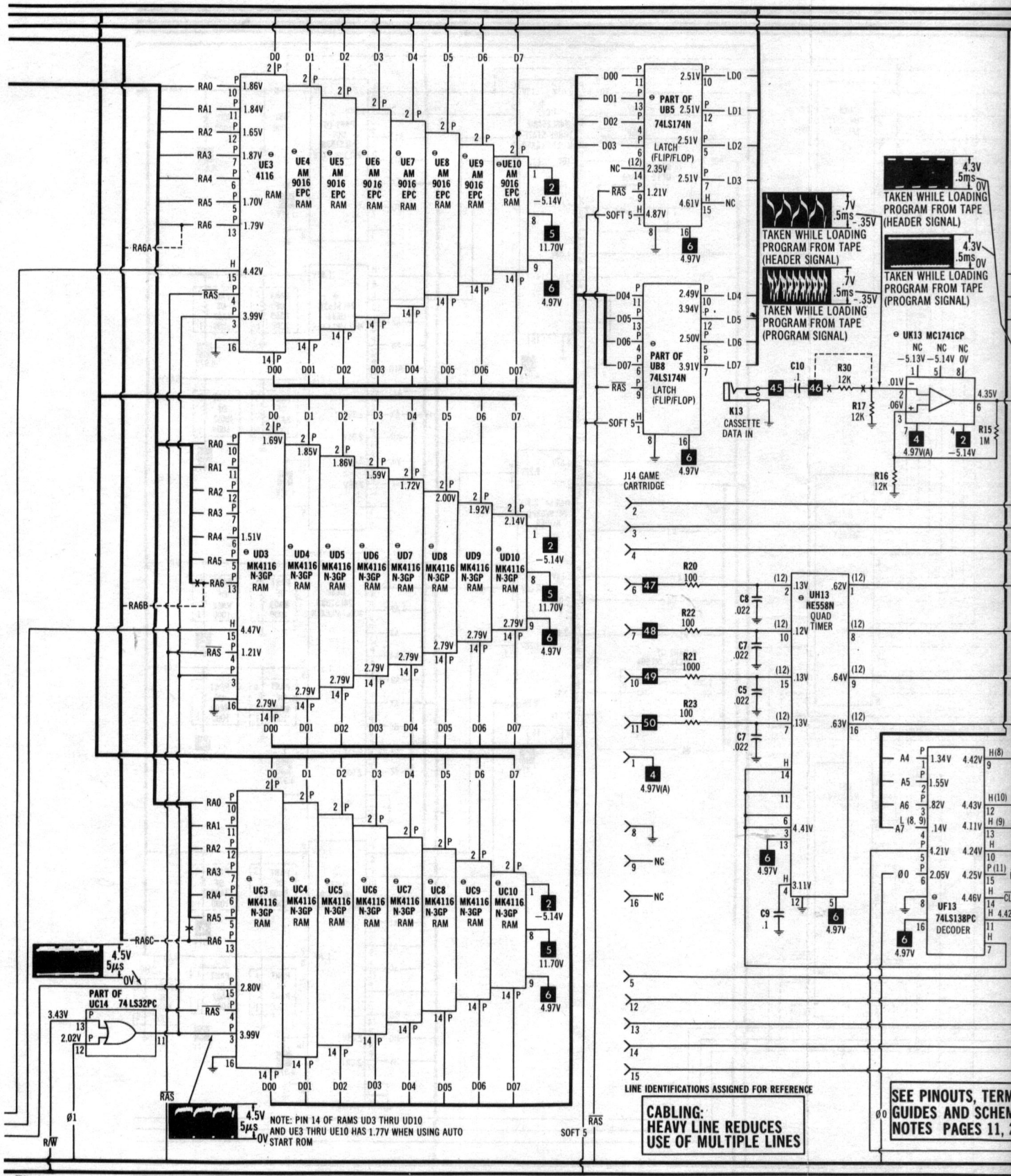

A PHOTOFAC STANDARD NOTATION SCHEMATIC

WITH **CIRCUITRACE**

© Howard W. Sams & Co., Inc. 1984

LOGIC (MAIN) BOARD

CABLING:
HEAVY LINE REDUCES
USE OF MULTIPLE LINES

**SEE PINOUTS, TERM
GUIDES AND SCHEM
NOTES PAGES 11, 2**

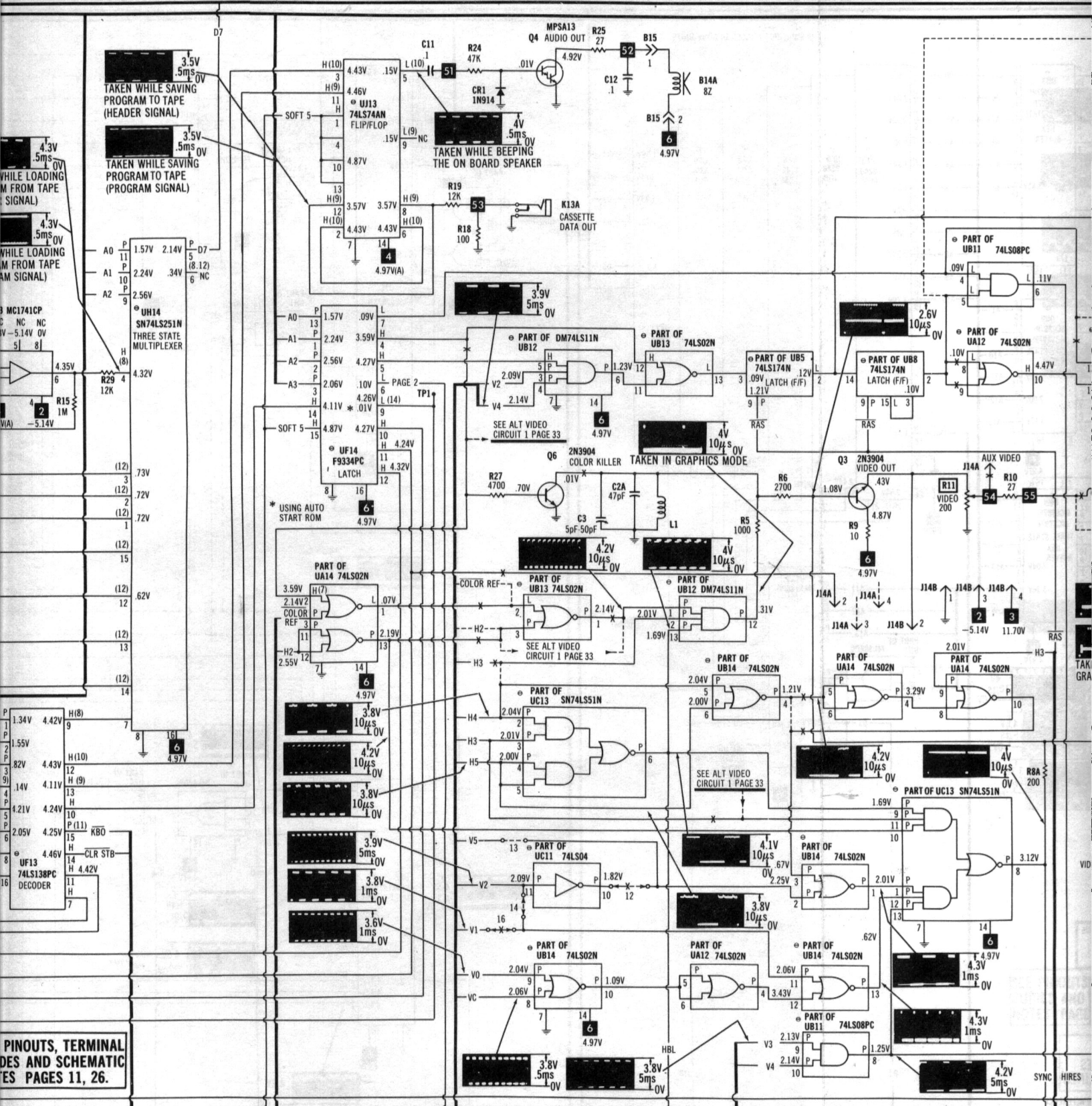

**PINOUTS, TERMINAL
DES AND SCHEMATIC
ES PAGES 11, 26.**

SEE LINE DEFINITIONS ON PAGE 14.

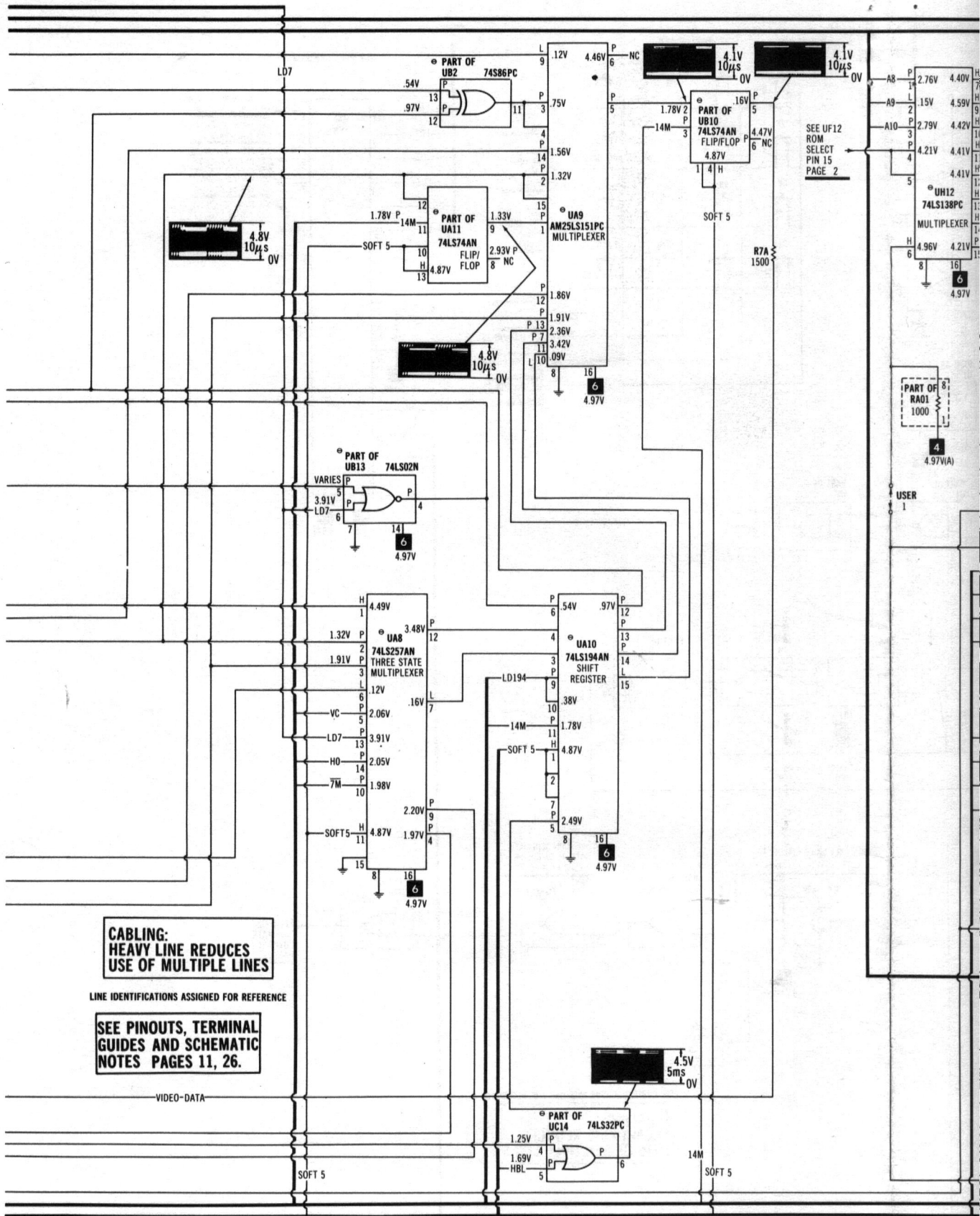

**CABLING:
HEAVY LINE REDUCES
USE OF MULTIPLE LINES**

LINE IDENTIFICATIONS ASSIGNED FOR REFERENCE

**SEE PINOUTS, TERMINAL
GUIDES AND SCHEMATIC
NOTES PAGES 11, 26.**

VIDEO-DATA

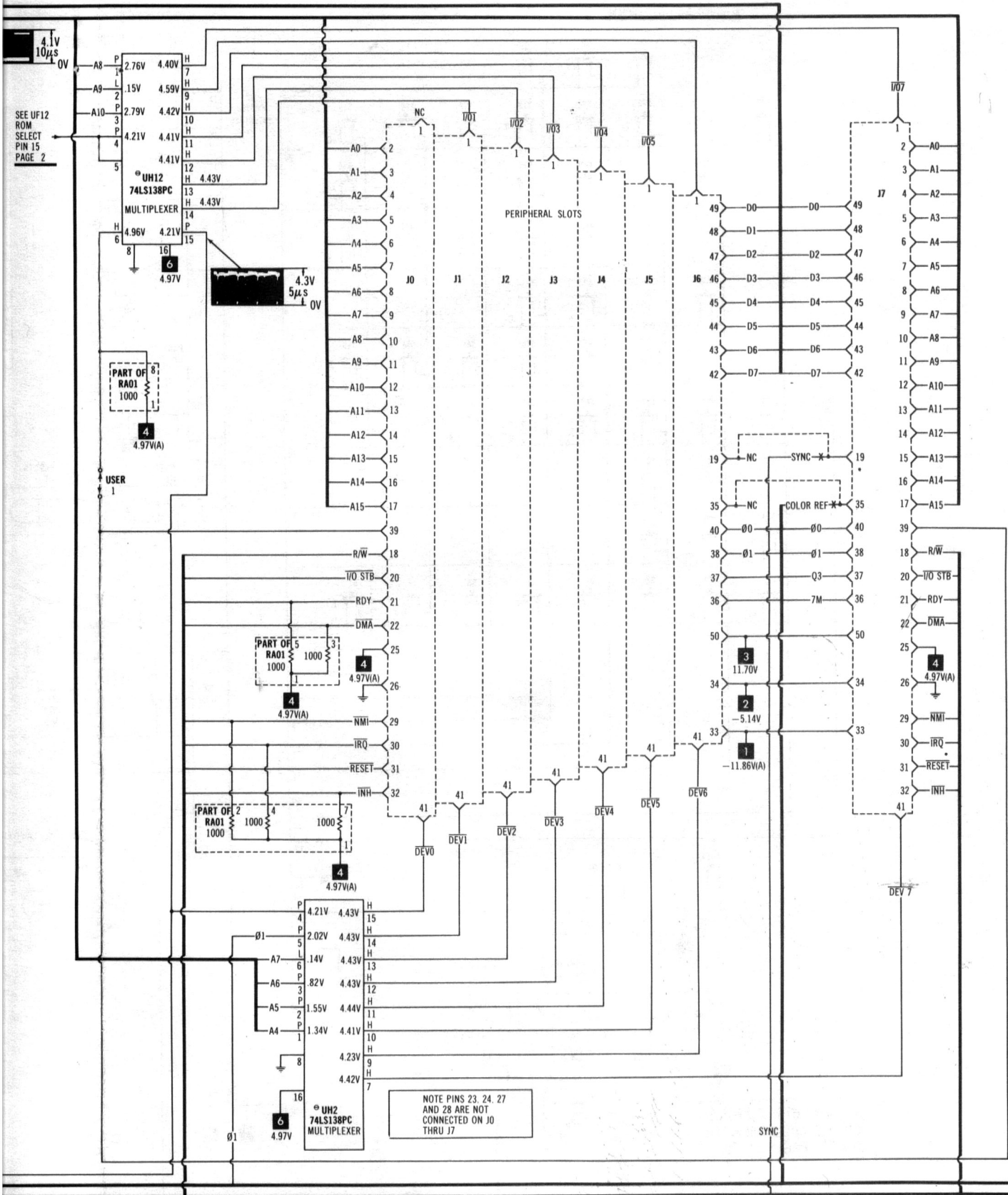

4.1V
10µs
OV

SEE UF12
ROM
SELECT
PIN 15
PAGE 2

PART OF
RA01
1000

4
4.97V(A)

USER
1

4.3V
5µs
OV

PART OF
RA01
1000

4
4.97V(A)

PART OF
RA01
1000

4
4.97V(A)

UH2
74LS138PC
MULTIPLEXER

4.21V 4.43V
2.02V 4.43V
.14V 4.43V
.82V 4.43V
1.55V 4.44V
1.34V 4.41V
4.23V
4.42V

6
4.97V

NOTE PINS 23, 24, 27
AND 28 ARE NOT
CONNECTED ON J0
THRU J7

SYNC

TIMING GENERATOR

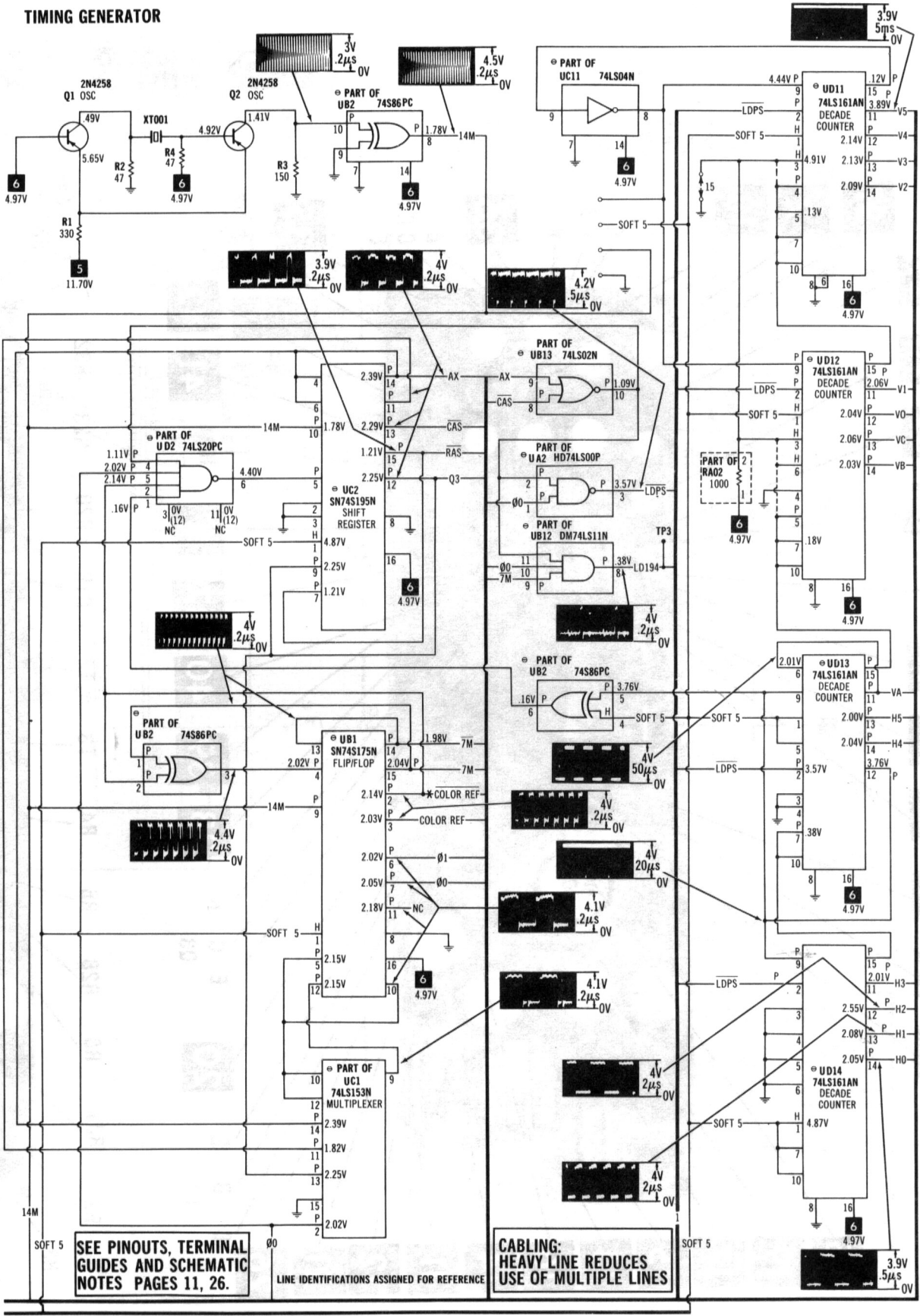

**APPLE
CC 1
MODELS II, II PLUS**

**SEE LINE DEFINITIONS ON PAGE 14.
LOGIC (MAIN) BOARD**

COMPUTERFACTS-OF-THE-MONTH SET NO. CF1 FOLDER CC 1

A PHOTOFACT STANDARD NOTATION SCHEMATIC
WITH **CIRCUITRACE**
© Howard W. Sams & Co., Inc. 1984

ALTERNATE ONE PIECE KEYBOARD

ALTERNATE CIRCUIT

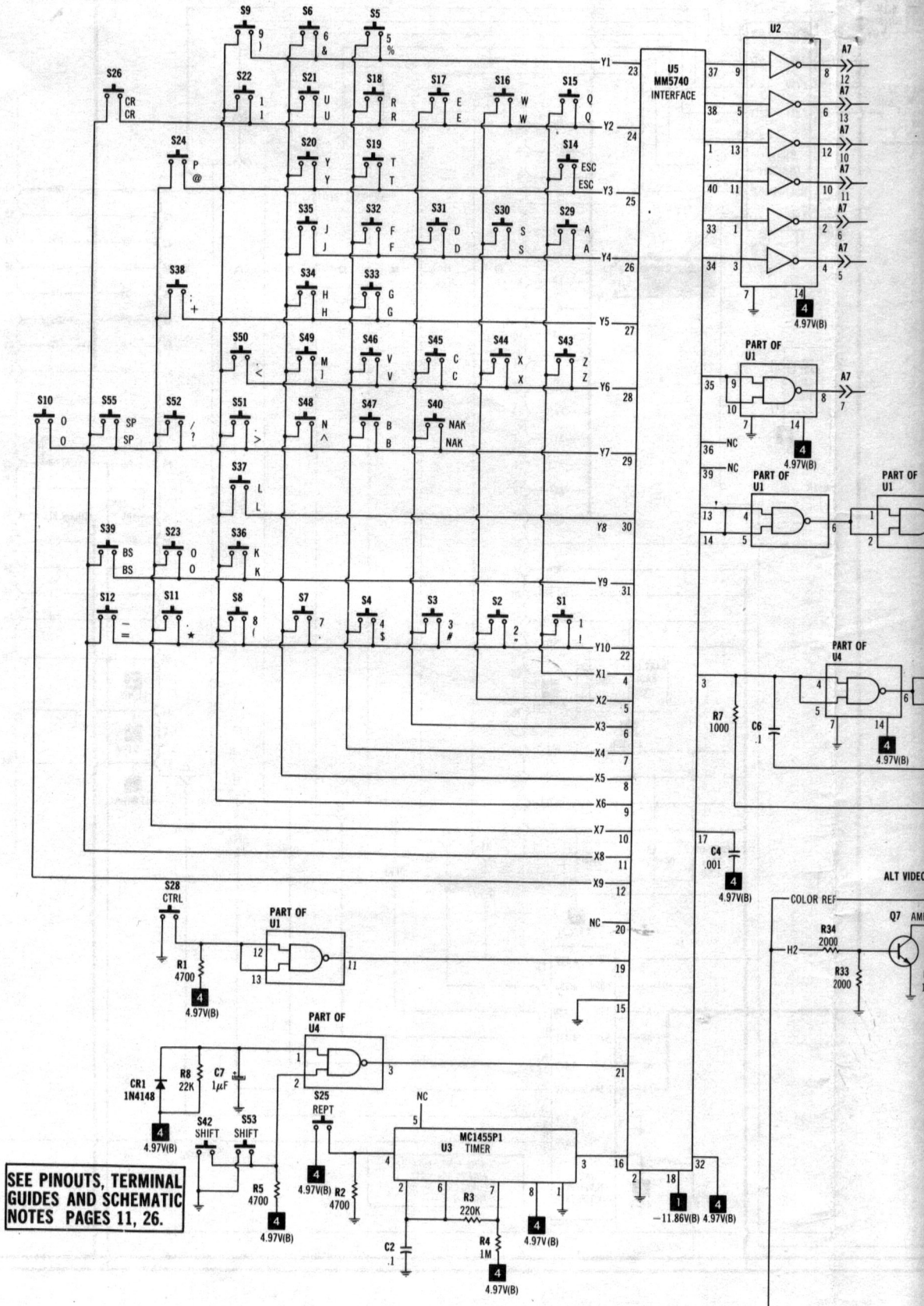

SEE PINOUTS, TERMINAL GUIDES AND SCHEMATIC NOTES PAGES 11, 26.

A PHOTOFACIT STANDARD NOTATION SCHEMATIC

WITH **CIRCUITRACE**

© Howard W. Sams & Co., Inc. 1984

ALTERNATE KEYBOARD w/ENCODER & NUMERIC KEY PAD

SEE LINE D

ALTERNATE CIRCUIT

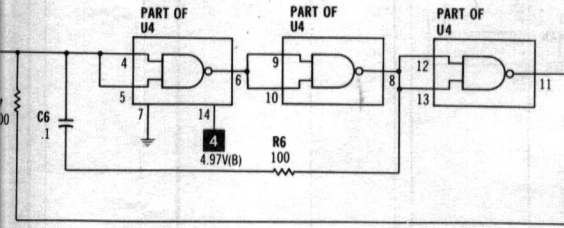
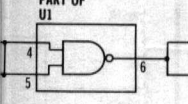
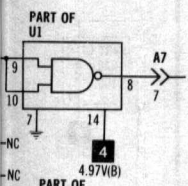
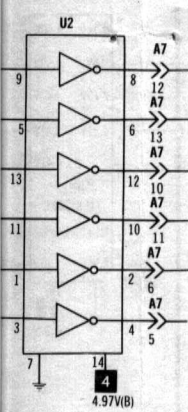

NUMERIC PAD

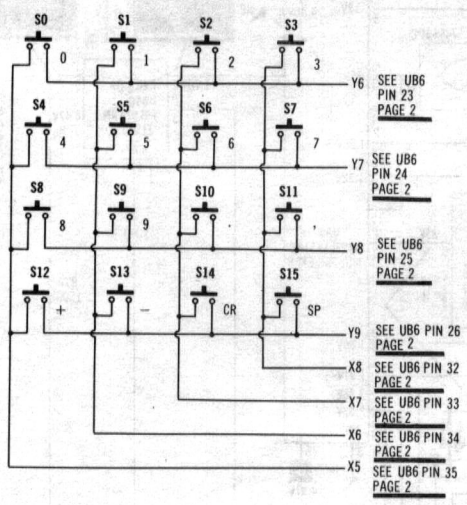

SEE UB6 PIN 23 PAGE 2
SEE UB6 PIN 24 PAGE 2
SEE UB6 PIN 25 PAGE 2
SEE UB6 PIN 26 PAGE 2
SEE UB6 PIN 32 PAGE 2
SEE UB6 PIN 33 PAGE 2
SEE UB6 PIN 34 PAGE 2
SEE UB6 PIN 35 PAGE 2

ALT VIDEO CIRCUIT 2

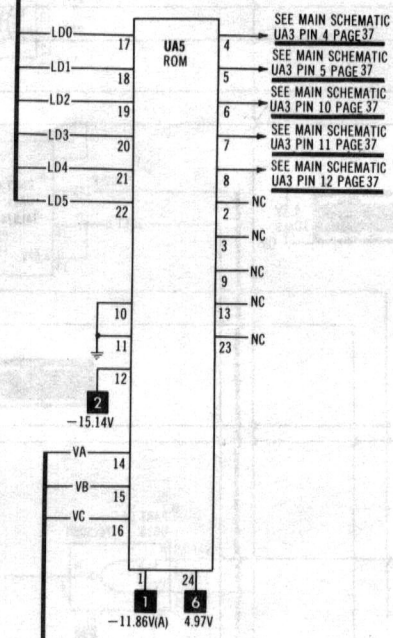

SEE MAIN SCHEMATIC UA3 PIN 4 PAGE 37
SEE MAIN SCHEMATIC UA3 PIN 5 PAGE 37
SEE MAIN SCHEMATIC UA3 PIN 10 PAGE 37
SEE MAIN SCHEMATIC UA3 PIN 11 PAGE 37
SEE MAIN SCHEMATIC UA3 PIN 12 PAGE 37

ALT VIDEO CIRCUIT 1

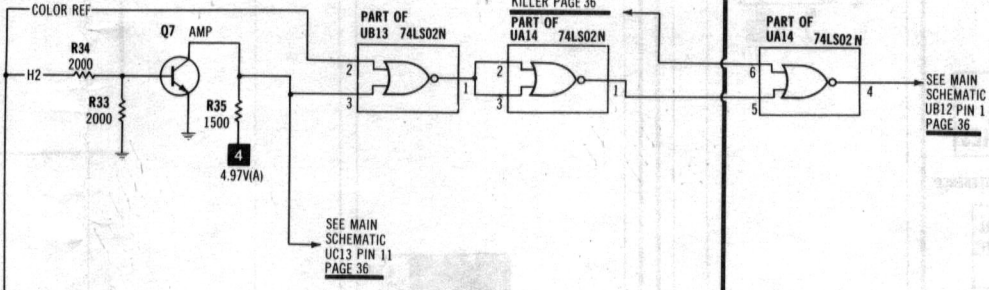

SEE MAIN SCHEMATIC BASE OF Q6 COLOR KILLER PAGE 36
SEE MAIN SCHEMATIC UA13 PIN 11 PAGE 36
SEE MAIN SCHEMATIC UA12 PIN 1 PAGE 36

LINE IDENTIFICATIONS ASSIGNED FOR REFERENCE
**CABLING:
HEAVY LINE REDUCES
USE OF MULTIPLE LINES**

SEE LINE DEFINITIONS ON PAGE 14.

ALTERNATE KEYBOARD w/ENCODER & NUMERIC KEY PAD

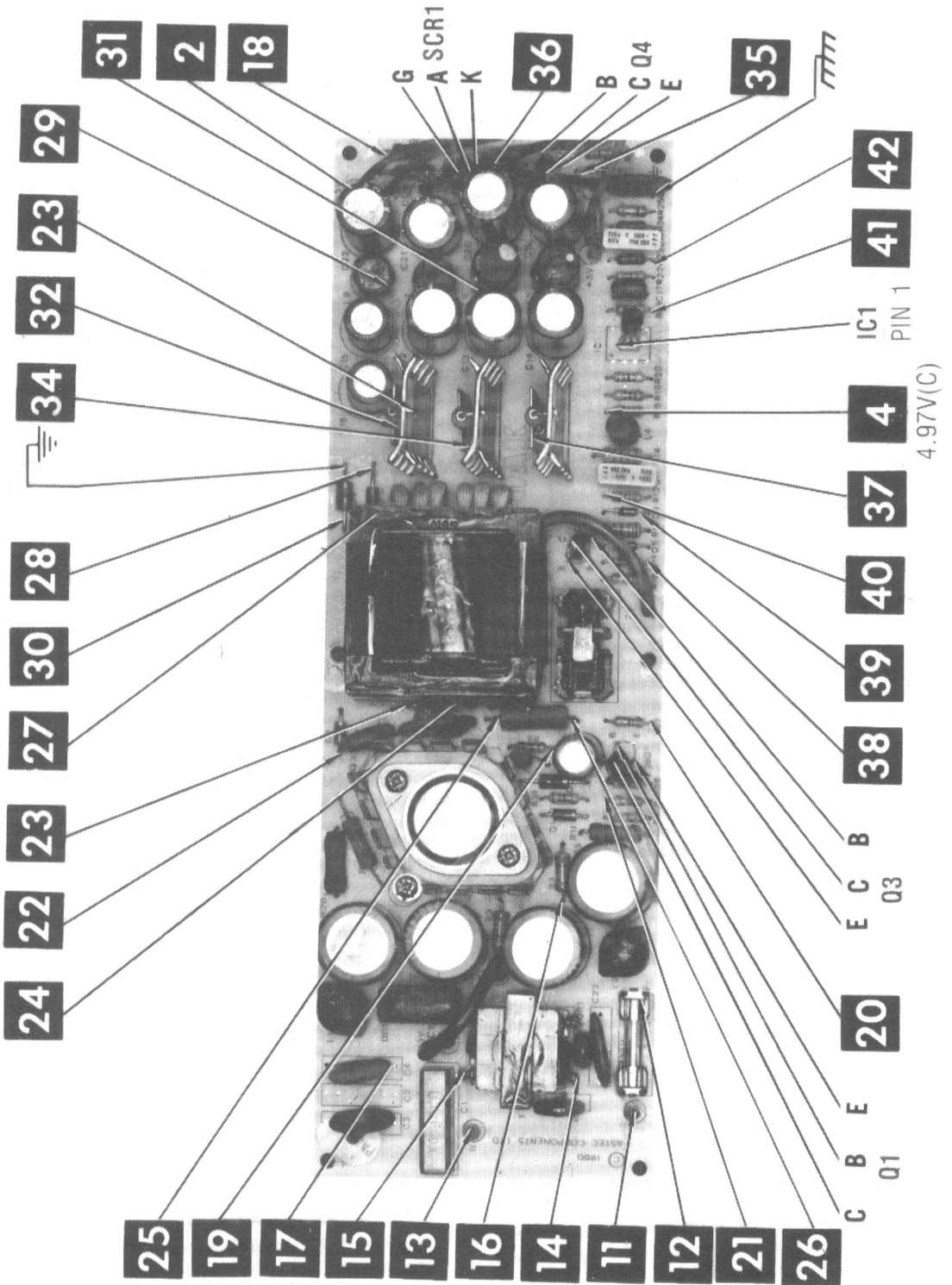

POWER SUPPLY BOARD

A Howard W. Sams **CIRCUITRACE** Photo

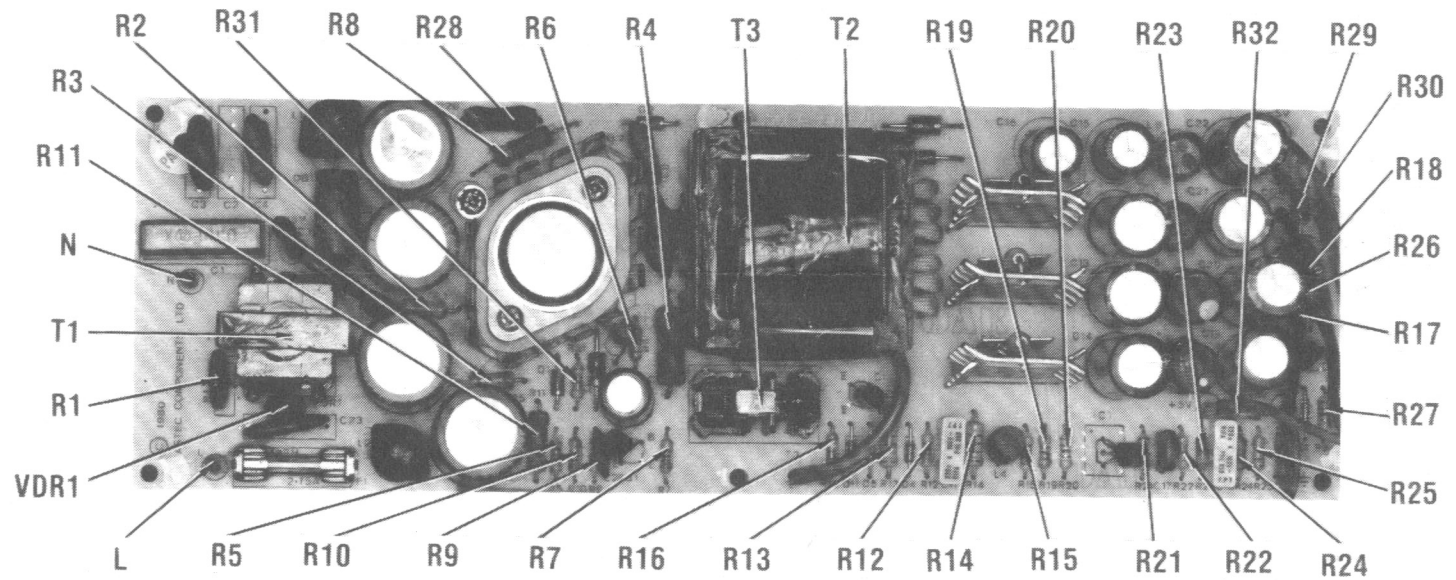

APPLE
MODELS II, II PLUS

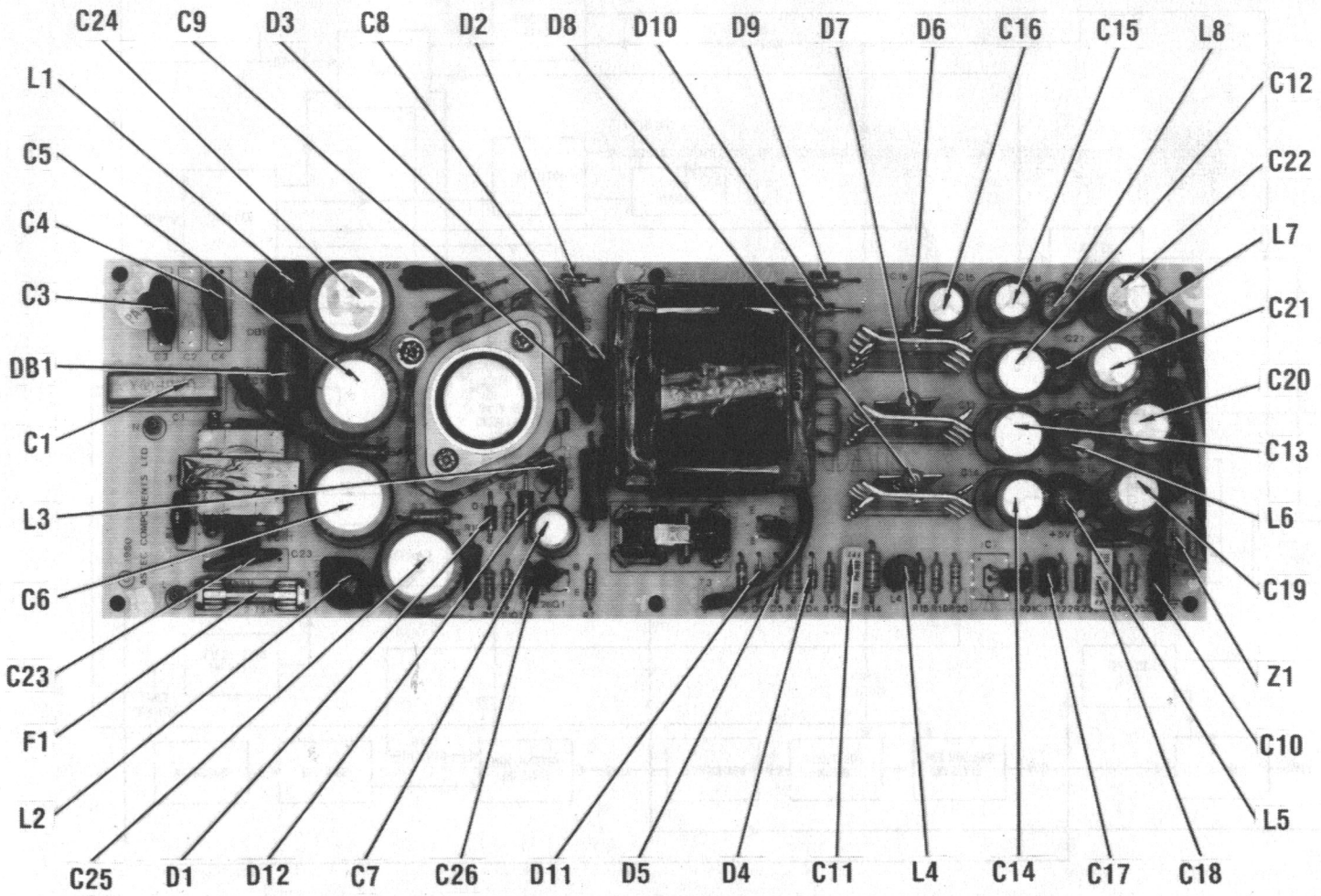

POWER SUPPLY BOARD

POWER SUPPLY

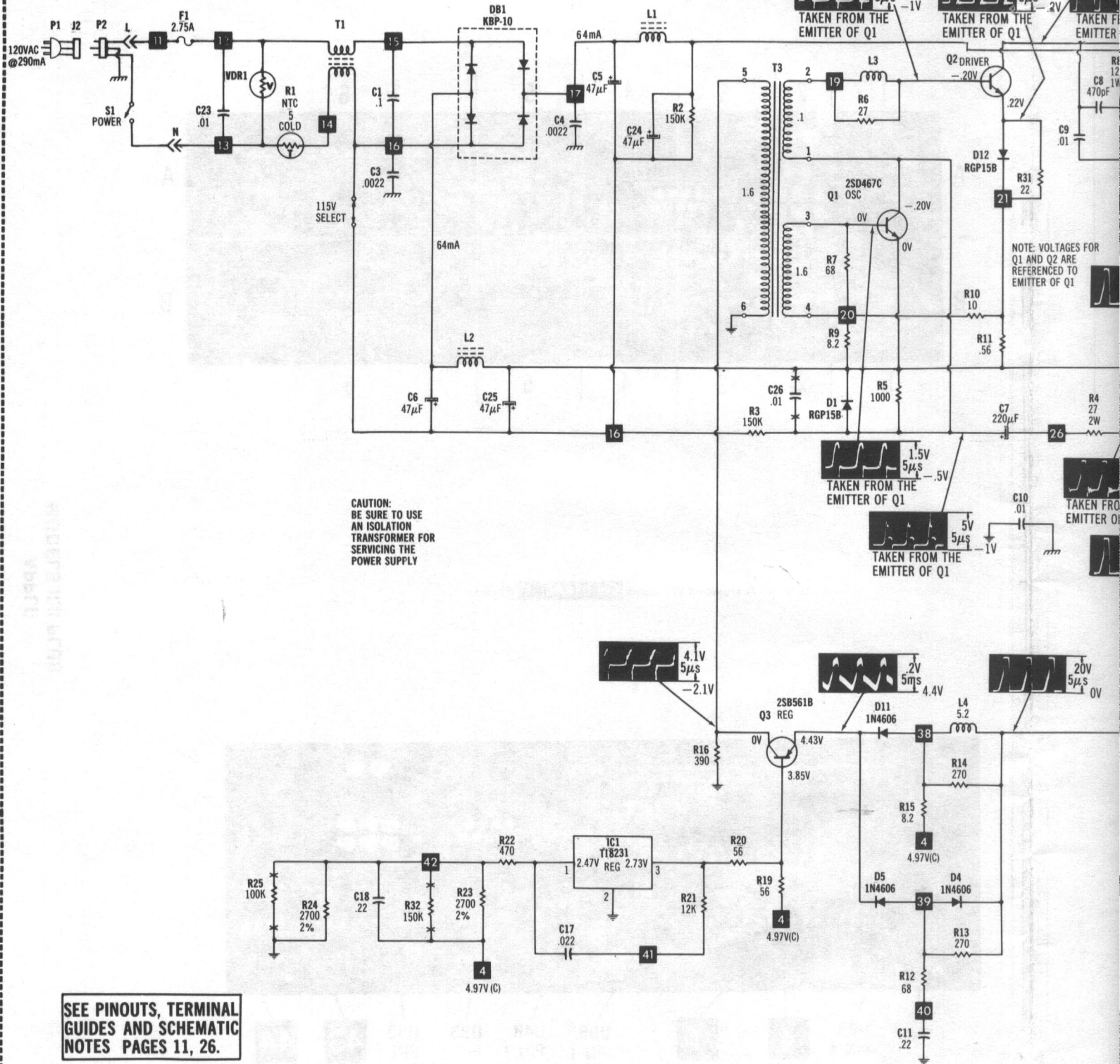

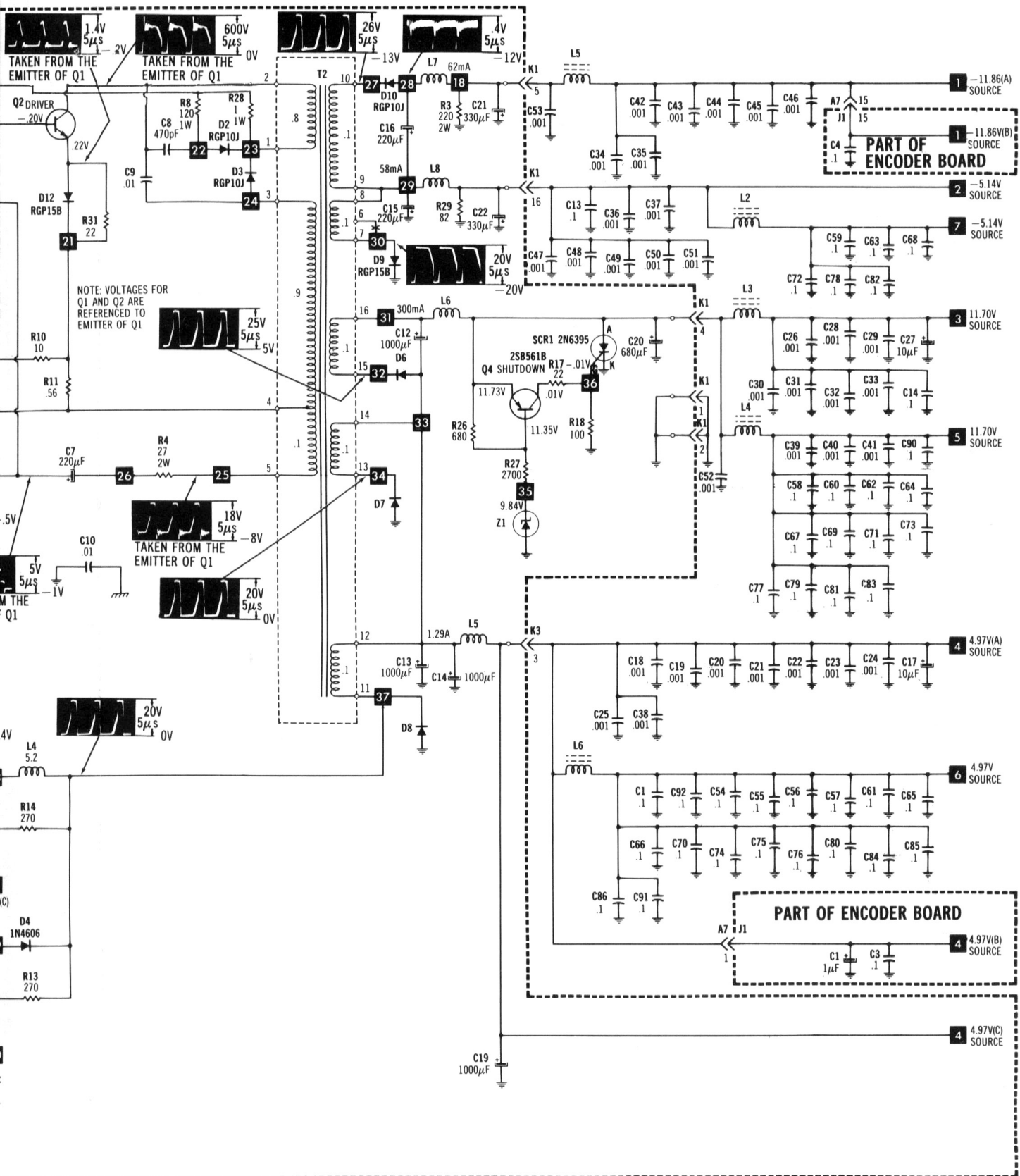

POWER SUPPLY BOARD

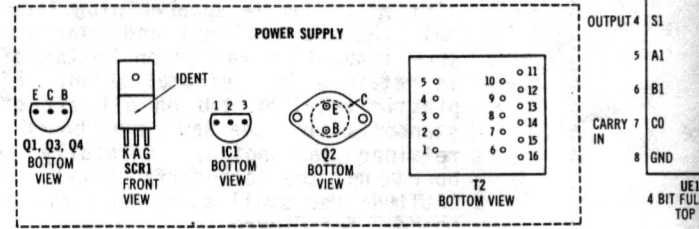
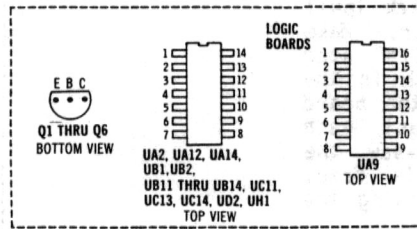
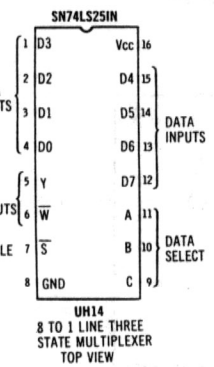
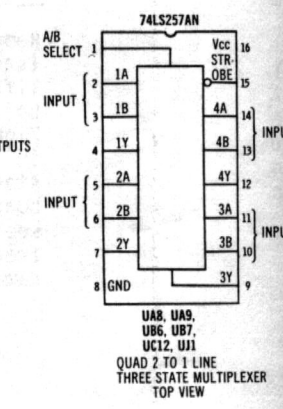
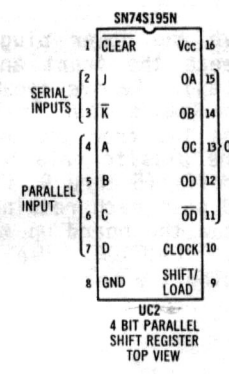
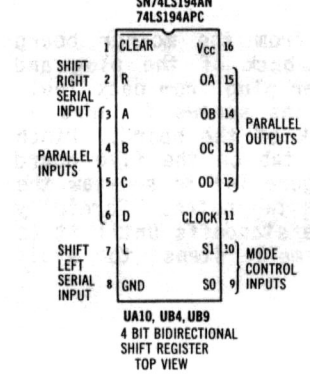
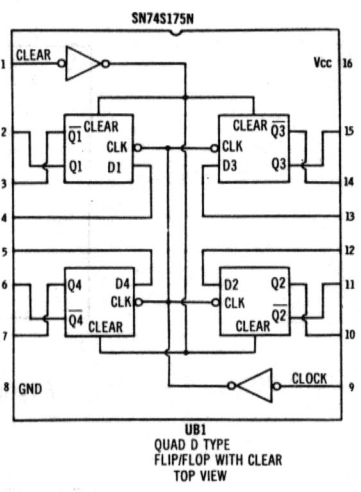
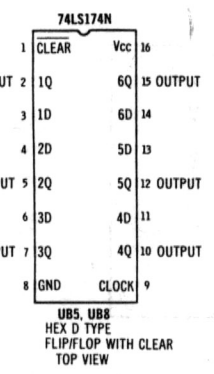
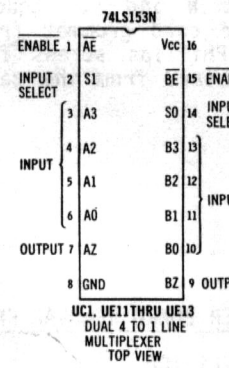
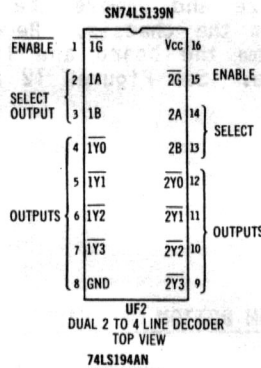
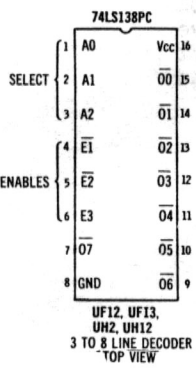
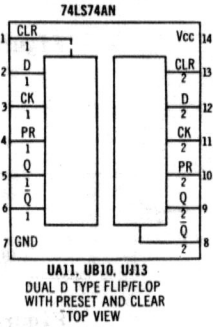
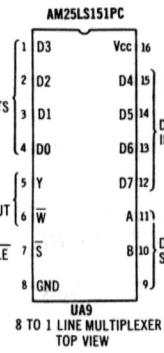
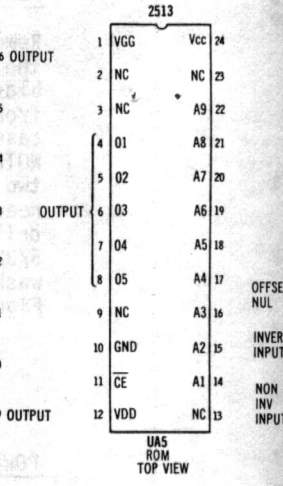
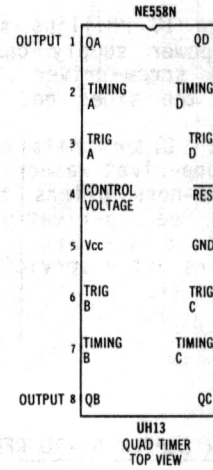
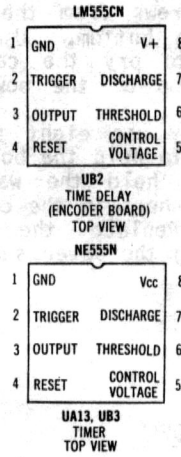
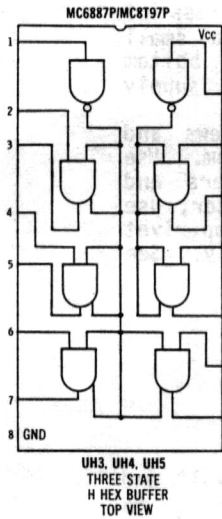
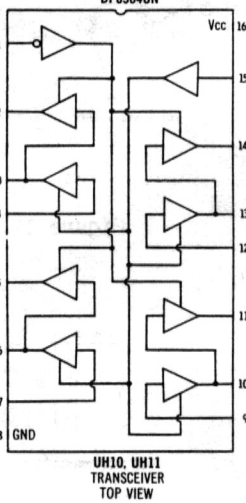
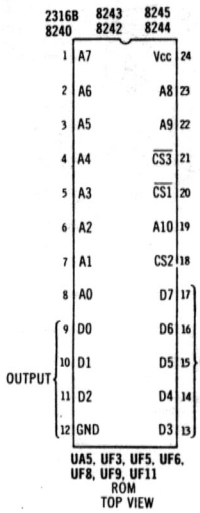

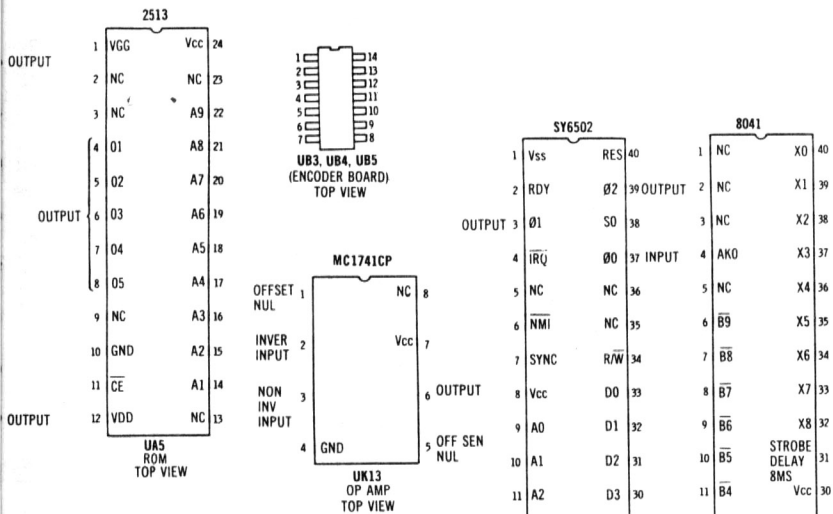

SCHEMATIC NOTES

- ✱ Circuitry not used in some versions
- Circuitry used in some versions
- ⊕ See parts list
- ⊗ Nominal value
- ⊥ Ground

Item numbers in rectangles appear in the alignment/adjustment instructions.

Supply voltages maintained as shown at input.

Voltages measured with digital meter.

Terminal identification may not be found on unit.

Voltages and Waveforms taken with Integer Basic in ROM and in Monitor mode unless noted. Waveforms taken with triggered scope and Sweep/Time switch in Calibrate position, scope input set for DC coupling on "0" reference voltage waveforms. Switch to AC input to view waveforms after DC reference is measured when necessary. Each waveform is 9 cm width with DC reference voltage given at the bottom line of each waveform. Time in μ sec. per cm, given with p-p reading at the end of each waveform.

Resistors are 1/2W or less, 5% unless noted. Value in () used in some versions.

NOTE: Logic probe readings taken after just turning computer on (power-up) unless otherwise noted. Unit with integer BASIC in ROM and without Auto-start ROM used for logic probe readings.

NOTE: RFI Revision with computer in Monitor mode.

- (1) Reading goes high when a key is pressed.
- (2) SHIFT, CTRL, REPT and RESET keys have no effect.
- (3) Reading goes high when SHIFT key is pressed.
- (4) Reading goes high when CTRL key is pressed.
- (5) Probe will show a pulse when a key is pressed.
- (6) Measured after pressing SPACE BAR on keyboard.
- (7) Low in Graphics mode.
- (8) Probe will show P while Loading a program from tape.
- (9) Probe will show P while Saving a program on tape.
- (10) Probe will show P while beeping the on-board speaker.
- (11) Probe will show H while Loading a program from tape.
- (12) Open.
- (13) Used only with Apple II plus.
- (14) With Auto-start ROM.
- (15) Readings taken with P and REPT keys depressed.

Logic Probe display

- L = Low
- H = High
- P = Pulse

